

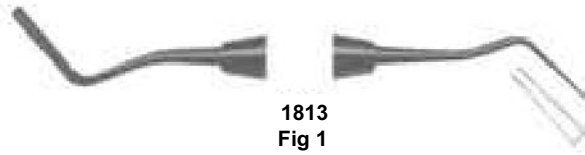

CORD PACKERS



1812



1813
Fig 1



1814
Fig 2



1815
BLOOMFIELD
Fig. 2(off angle)



1816
Fig. 1



1817
CSI-1(slightly serrated on ends)

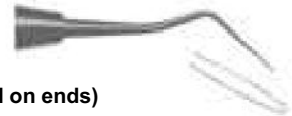

HATCHETS



1818
1mm(10-7-14)



1819
1.3mm(13-10-16)



1820
1.5mm(18-8-14)

HOES

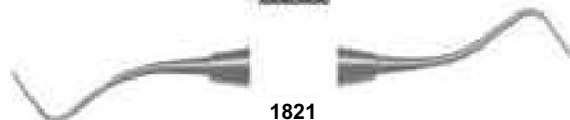

1821
1mm(10-8-16)

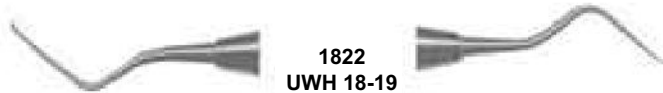

1822
UWH 18-19



1823
UWH 16-18



1824
UWH 20-21



PK.Thomas Waxing & Gracey Curetts Set



1825
PK.Thomas 1



1826
PK.Thomas 2



1827
PK.Thomas 3



1828
PK.Thomas 4



1829
PK.Thomas 5

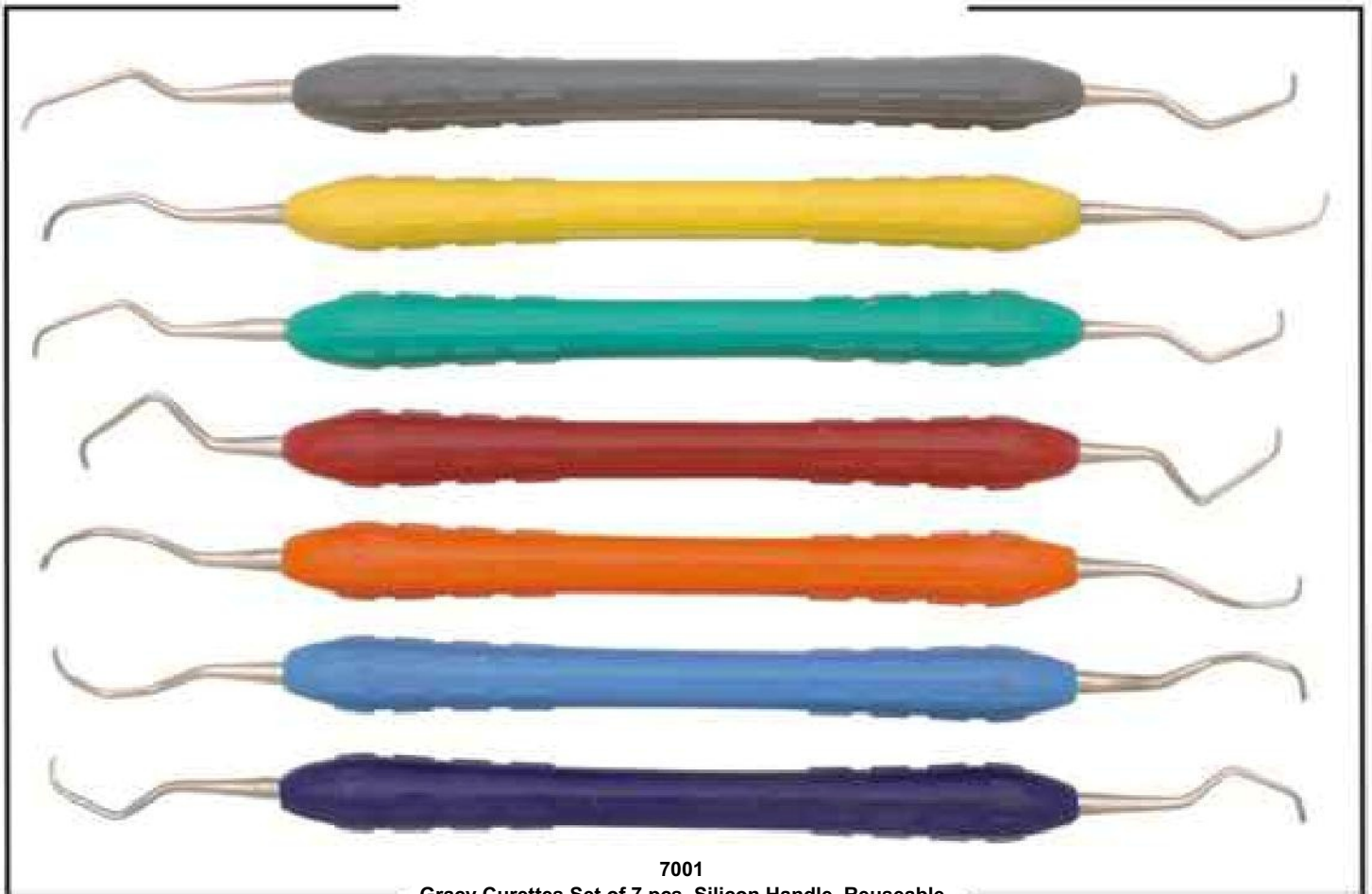

7001
Gracy Curettes Set of 7 pcs, Silicon Handle, Reuseable



Amalgam Pluggers/ Condensers/ Applicators



1830
BEHRMAN (Fig. 1)



1831
BLACK (Fig. 1-2)



1832
MORQUETTE (Fig. 0/1)



1834
Hollenback No.1 Plugger



1835
Hollenback No.2 Plugger



1833
Black Action 11/12 Plugger



1836
Hollenback No.3 Plugger



1837
Blacks0.1 (1mm-1.5mm)



1838
Blacks1.5 (1.5mm-2.5mm)



1839
Bodkin 1 (.7mm-1mm)



1843
7mm-1mm



1844
1mm-1.5mm



1840
Bodkin 2 (1.5mm-2mm)



1841
2.5mm 3mm



1845
1.5mm-2mm



1846
Oregon (Fig. 3)



1842
Oregon 2



1847
Oregon (Fig. 4)



1848
UP 12



1849
Applicator 1-2

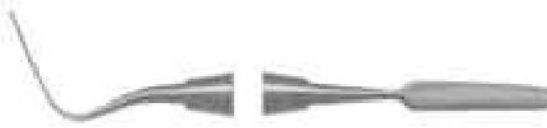

1850
Birtles Applicator Spatula

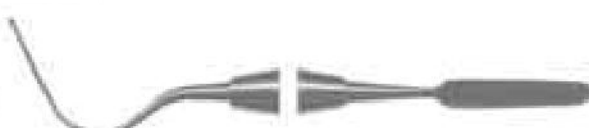

1851
Birtles Applicator Spatula K20-21



**Placement Instruments,
Stopping Stoppers, Plugg**

Placement Instruments



1852
PICH (Calcium Hydroxide Placer)



1853
CA

Stopping Stoppers



1854
Woodson 2

Ø 1.6 mm

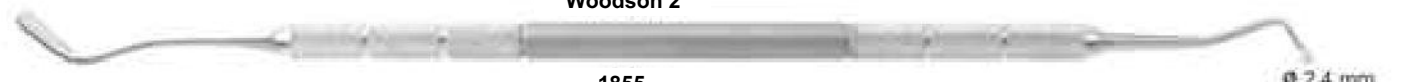

1855
Woodson 3S

Ø 2.4 mm



1856
Woodson 3A

Ø 2.6 mm



1857
Woodson 3

Ø 3.0 mm

Pluggers



Ø 0.75 mm

1858
Plugger 0-1

Ø 1.2 mm



Ø 1.2 mm

1859
Plugger 1-4

Ø 1.6 mm



Ø 1.6 mm

1860
Plugger 4-6

Ø 2.0 mm



Ø 2.0 mm

1861
Plugger 6-8

Ø 2.5 mm



Ø 1.5 mm

1862
Black 1-2

Ø 2.6 mm



Ø 3.6 mm

1863
Black 2-3

Ø 5.0 mm

Section - 03

- Burnishers • Carvers • Chisels
- Composite Placements
- Filling Instruments • Curettes
- Disposable Instruments





Burnishers

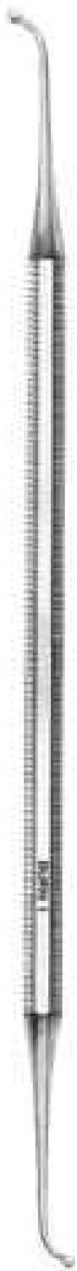

1864
Fig. 1



1865
Fig. 28/29

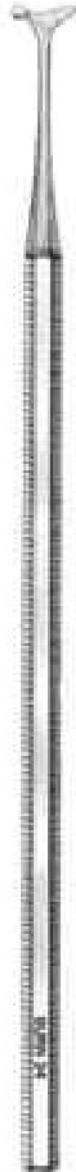

1866
Fig. 34

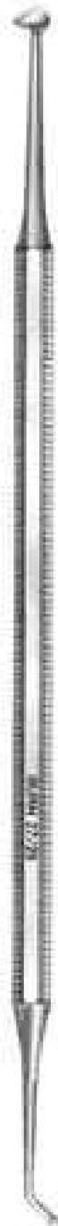

1867
Fig. 27/29

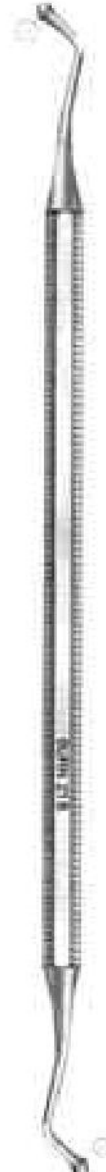

1868
Fig. 21B

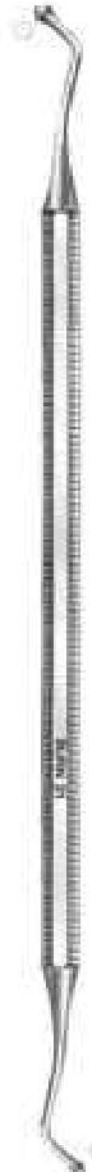

1869
ACORN
Fig. 21



Burnishers



1870
21 Acom



1871
Fig. 21B



1872
Fig. 2-34



1873
Fig. 21C



1874
Fig. 26-28



1875
Fig. 2-30



1876
Fig. 25-30



1877
Fig. 27-29



1878
PKT1



1879
Fig. 27-30



1880
PKT2



1881
Fig 34T



1882
Fig 3



1883
PKT3



1884
PFI21



1885
PKT 3P



1885
Pitts Podo 19



1887
PKT 4



1888
Pitts Podo 18



1889
PKT 5





Wax Carvers

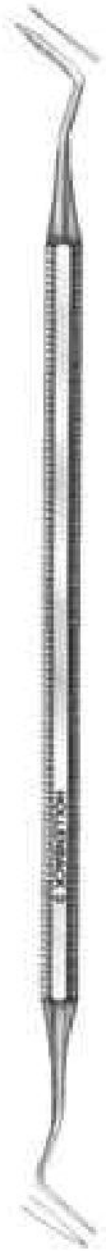

1890
HOLLENBACK
Fig. 3



1891
HOLLENBACK
Fig. 3S

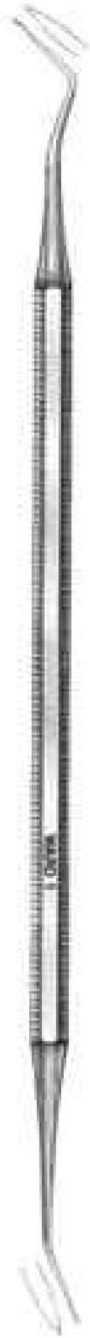

1892
WARD
Fig. 1



1893
WARD
Fig. 2

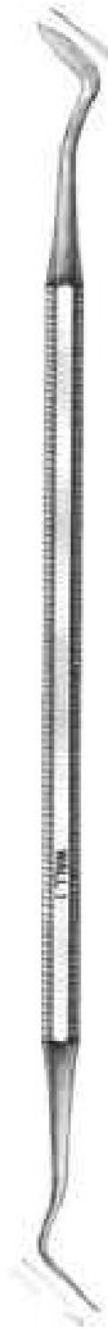

1894
WALL
Fig. 1



1895
WALL
Fig. 3



1886
Fig. 3/6
Cleoid/Discoïd

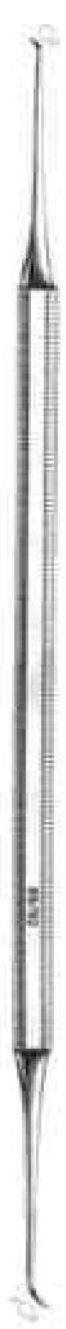

1897
Fig. 89/92
Cleoid/Discoïd



Carvers



1898
1.5mm Cleoid Discoid (Shown with GTX Finish)



1899
2mm Cleoid Discoid



1901
3mm Cleoid Discoid



1900
GOLLOBIN
Fig. 1



1902
HOLLENBACK
Fig. 1/2



1903
FRAHM
Fig. 2-3 (off-angle)



1904
HOLLENBACK
Fig. 3



1906
THOMPSON (Fig. 3)
1/2 Hollenback Hoe & Wall 3



1908
THOMPSON (Fig. 5)
1/2 Hollenback Hoe & Tanner 5



1905
Interproximal 1



1907
Interproximal 1



1909
Baum Interproximal



1910
THOMPSON (Fig. 8)
3mm Cleoid & Wall 3



1911
SHO A Carver



1912
THOMPSON (Fig. 9)
Hollenback 3 & Wall 3



1913
Thompson 2



1914
WARD
Fig. 2



Carvers, Chisels



1915
Composite Interproximal



1916
TANNER
Fig. 5



1920
University of Minnesota
Fig. 1



1917
TANNER
Fig. 0



1921
University of Minnesota
Fig. 2



1918
THARP
Fig. 1



1922
UPR
Fig. 1



1919
THOMPSON
Fig. 1



1923
WALL
Fig. 3



Contour Carbide Carvers - Finishing



1924
COUNTER CARBIDE Fig 1-2



1925
Cleoid Carbide



1926
Cleoid Carbide (Fig 10-11)

Chisels



1927
1.5mm Bin Angle (15-8-8)



1928
1.5mm Straight (15)



1930
1.5mm Wedelstaedt(15-15-3)



1929
1mm Wedelstaedt(10-15-3)



1931
2mm Wedelstaedt(20-15-3)



Composite Placement

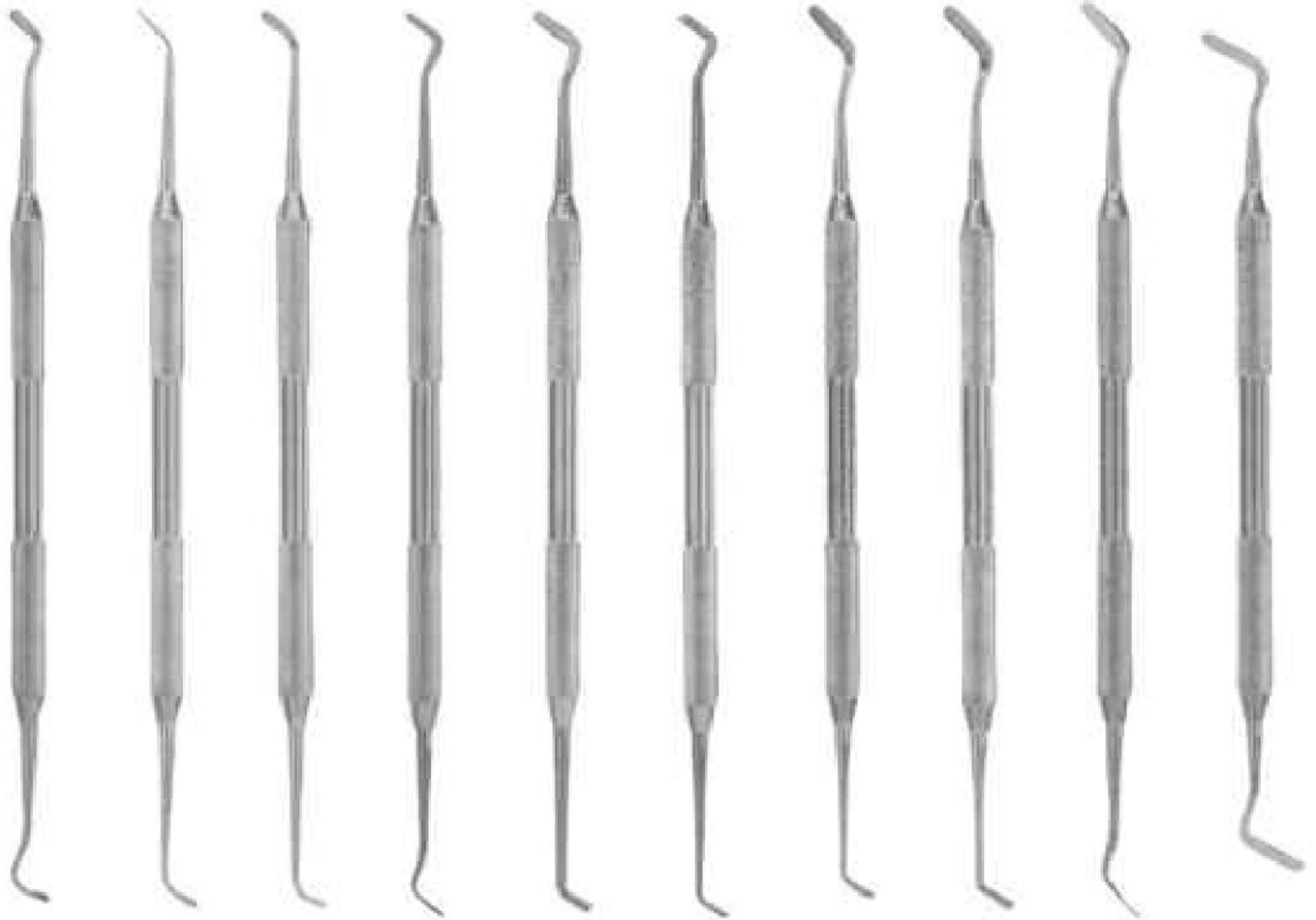

1932
F-Type 1

1933
F-Type 2

1934
F-Type 3

1935
F-Type 4

1936
F-Type 5

1937
F-Type 6

1938
G-Type 1

1939
G-Type 2

1940
G-Type 3

1941
G-Type 4

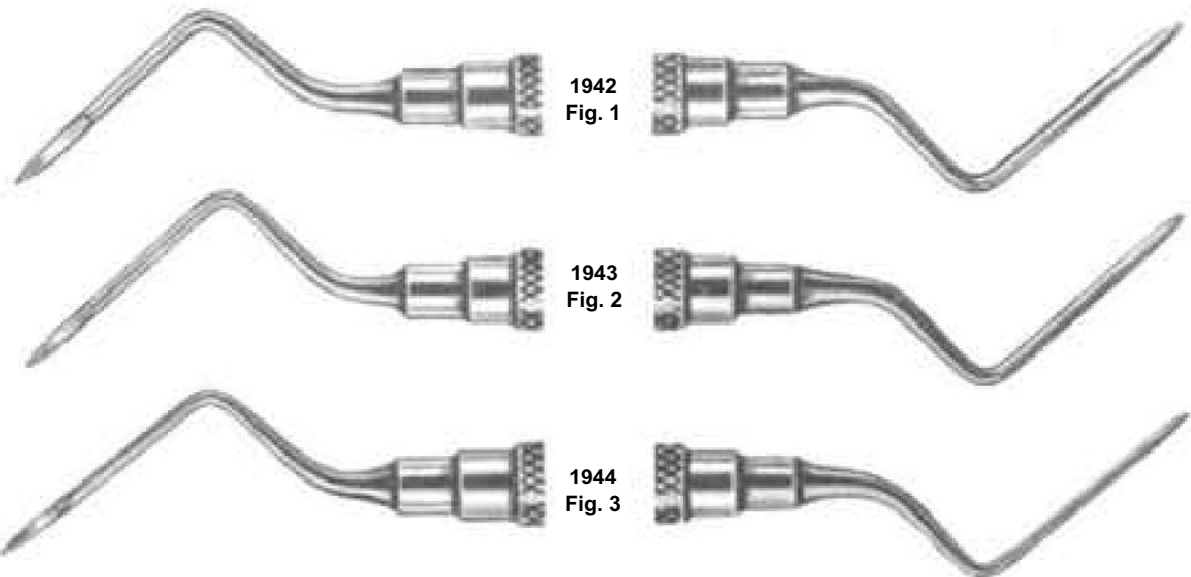

1942
Fig. 1

1943
Fig. 2

1944
Fig. 3



Composite Placement



1945
Fig. 2



1946
Fig. 3 (off-set blade)



1947
Fig. 4



1948
Fig. 5

1954
Fig. 12



1949
Fig. 6



1950
Fig. 7



1951
Fig. 8

1955
Fig. 15



1952
Fig. 9



1953
Fig. 11



1956
JORDAN
Fig. 2



1957
FREEDMAN
Fig. 1



1957
FREEDMAN
Fig. 1



1959
FREEDMAN
Fig. 2



1959
FREEDMAN
Fig. 3



1960
Dr. Dan



1961
SIMON
Fig. 2



K - Type



1962
K-Type 1



1963
K-Type 2

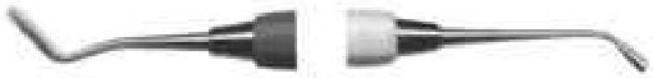

1965
K-Type 4

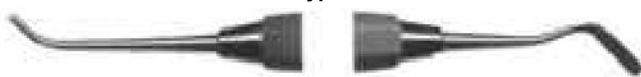

1964
K-Type 3



1966
K-Type 5



1967
K-Type 6 Carbide



Plastic Filling Instruments



1968
No.3

1969
No.4

1970
No.5

1971
LADMORE
Fig.3

1972
WOODSON
Fig.1

1973
WOODSON
Fig.2

1974
WOODSON
Fig.3

1975
W-3

1976
Gregg
4/5



Plastic Filling Instruments



1977
Fig. 5-7



1978
Fig. 1



1979
Fig. 3



1983
GUCK
Fig. 1



1980
Fig. 4



1984
P8



1981
Fig. 5-7



1985
WOODSON
Fig.1



1982
Fig. 8A



1986
WOODSON
Fig.2



1987
WOODSON
Fig.3





Curettes



1888
GRACY
GC 1-2



1889
GRACY
GC 3-4



1890
GRACY
GC 5-6



1891
GRACY
GC 7-8



1892
GRACY
GC 9-10



1893
GRACY
GC 11-12



1894
GRACY
GC 13-14



Gracy Curettes



1995
G1-2

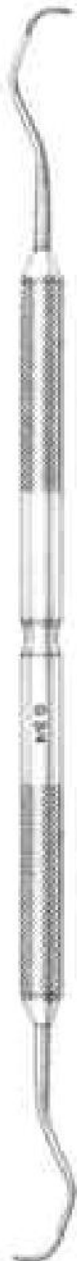

1996
G3-4

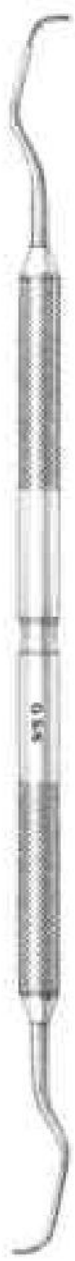

1997
G5-8



1998
G7-8

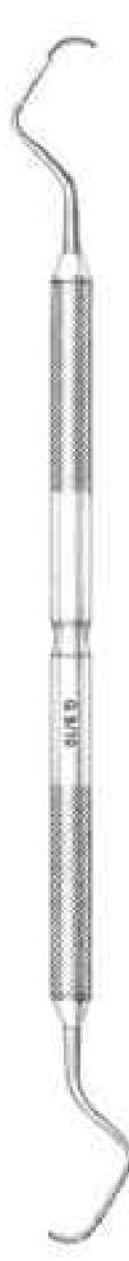

1999
G9-10



2000
G11-12

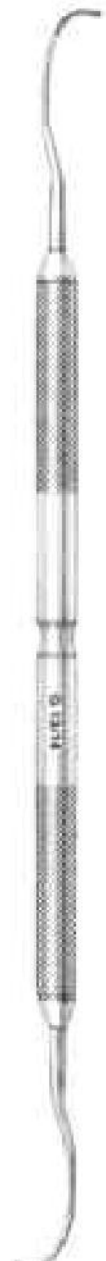

2001
G13-14



Curettes # 4. Handle

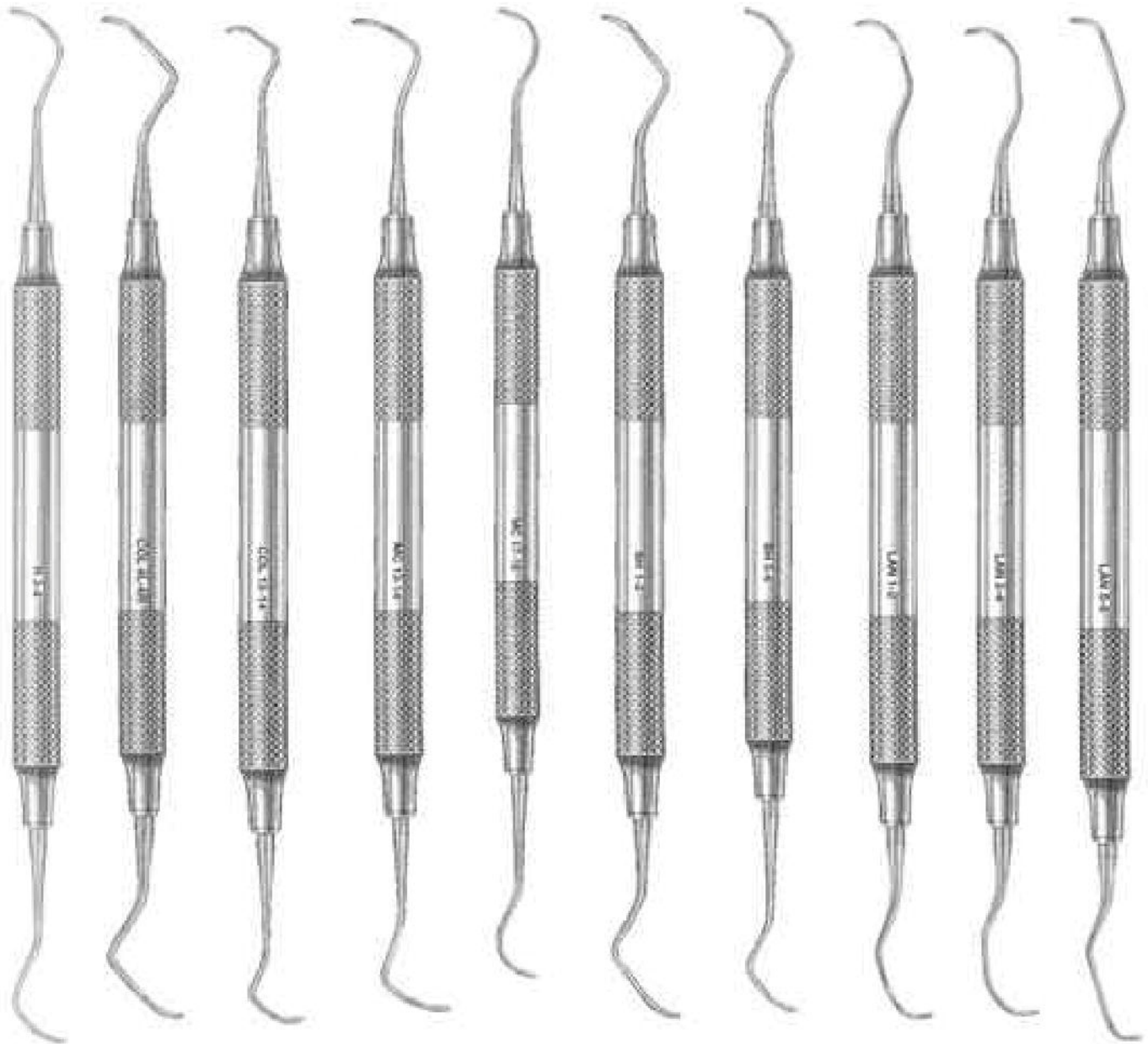

2002
RULE
3-4

2003
COLUMBIA
4\$-4L

2004
COLUMBIA
13-14

2005
MCCALLS
13-14

2006
MCCALLS
17-18

2007
BARNHART
1-2

2008
BARNHART
5-6

2009
LANGER
1-2

2010
LANGER
1-2

2011
LANGER
5-6



Curettes

COLUMBIA CURETTES



2012
4L-4R

2013
13-14

2014
2L-2R

MCCALLS CURETTES



2015
13-14

2016
13S-14S

2017
17-18

2018
17S-18S



Curettes

GOLDMAN FOX



2019
GF 1 Universal Scaler



2020
GF 2 Curette



2021
GF 3 Curette



2022
GF 4 Curette



2023
GF 5 HOE



2024
GF 6 HOE



Curettes

GOLDMAN FOX



2025
GF 7 Knife



2026
GF 8 Super Knife



2027
GF 9 Knife Scaler



2028
GF 11 Super Knife



2029
GF 21 Sharp Spoon/
Small Scaler



Knives, Interproximal Files



2030
GF 6 Krikland 15/16



2031
Ordan 1/2



2032
Buck 3/4



2033
Buck 5/8



2034
Goldman Fox 7



2035
Goldman Fox 8



2036
Goldman Fox 9



2037
Goldman Fox 11



2038
CK 3(Crane)

Interproximal Files



2039
Sugarman 1S-2S



2040
Sugarman 3S-4S



2041
Sugarman 9-10



2042
Buck 11-12



Curettes, Root Planning Curettes



2043
COLUMBIA (2L-2R)



2044
MCCALL (13-14)



2045
MCCALL (17S-18S)

Root Planning Curettes



2046
Root Plane (1-2)



2047
Root Plane (5-6)



2049
Root Plane (11-12)

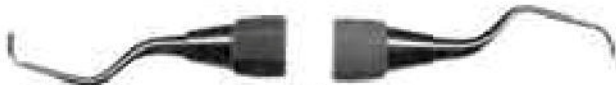

2048
Root Plane (17-18)



2050
Root Plane (13-14)

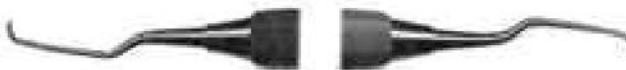

2051
Petite(1-2)



2052
Petite(11-12)



2053
Petite(5-6)



2054
Petite(13-14)



Curettes



2055
BARNHART (1-2)



2056
BARNHART (5-6)

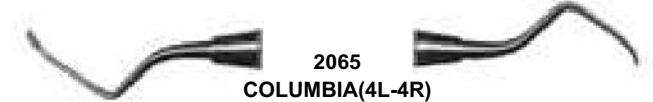

2065
COLUMBIA(4L-4R)

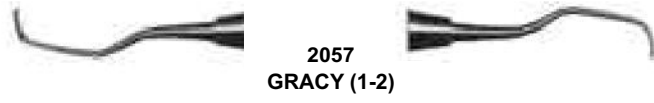

2057
GRACY (1-2)

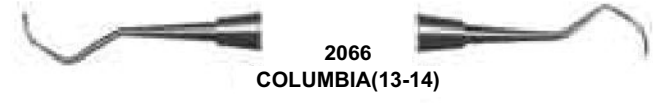

2066
COLUMBIA(13-14)

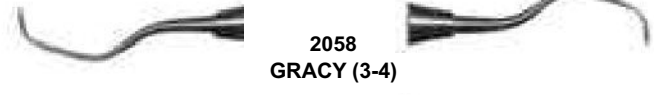

2058
GRACY (3-4)



2067
LANGER (1-2)

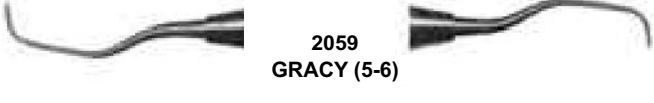

2059
GRACY (5-6)



2068
LANGER (3-4)

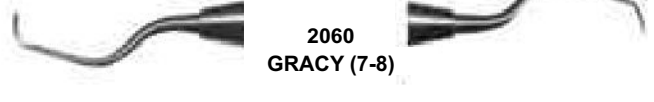

2060
GRACY (7-8)



2069
LANGER (5-6)

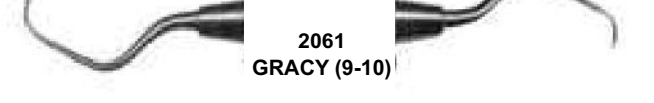

2061
GRACY (9-10)

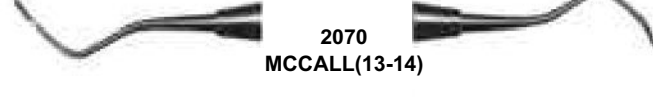

2070
MCCALL(13-14)

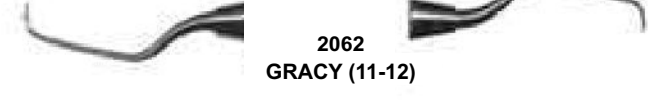

2062
GRACY (11-12)

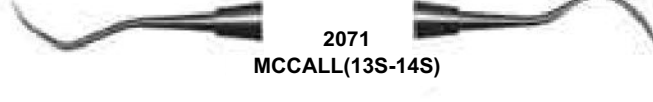

2071
MCCALL(13S-14S)

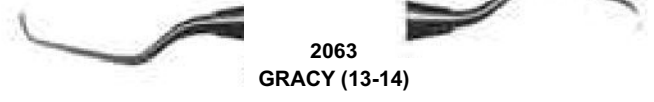

2063
GRACY (13-14)

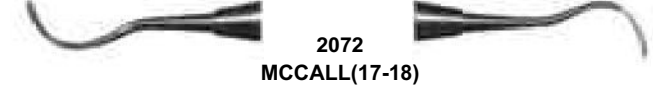

2072
MCCALL(17-18)

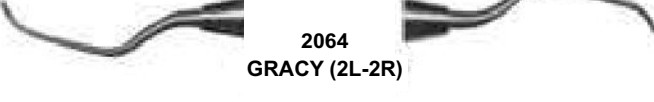

2064
GRACY (2L-2R)

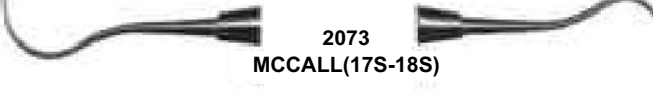

2073
MCCALL(17S-18S)

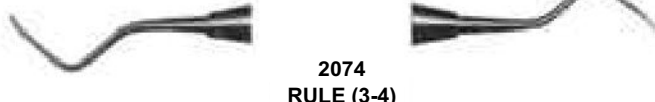

2074
RULE (3-4)

Section - 04

- Cement Instruments • Spatulas
- Knives • Bone Currettes & Files
- Bone Chisels • Bone Mallets
- Crown Remover
- Implant Instruments





Dental Products

Silicon Handles-Reusable

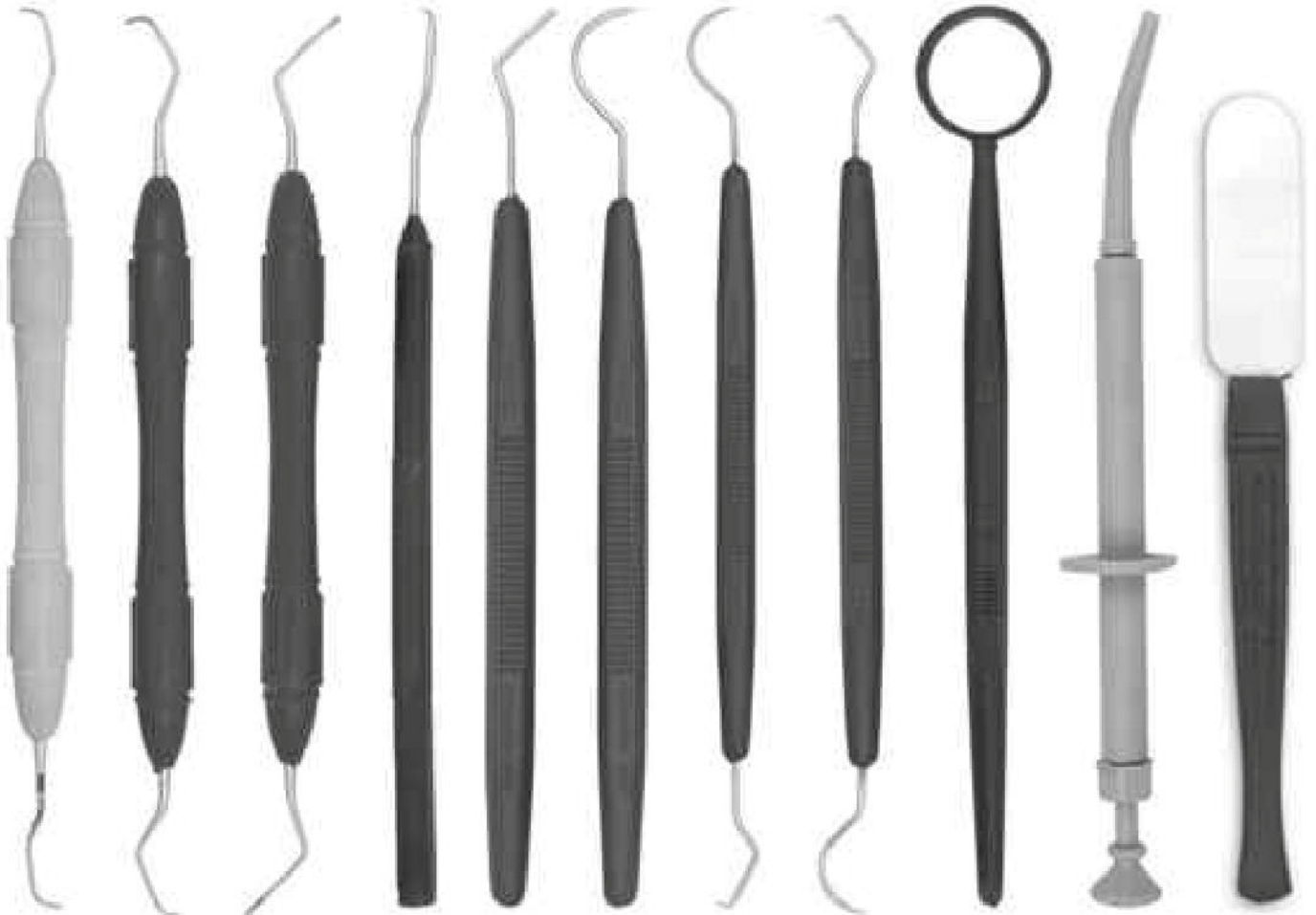

2075 2076 2077 2078 2079 2080 2081 2082 2083 2084 2085



2086 2087 2088 2089 2090



Comfort Grip
Vinyl - Covered Insulating Handles



2091 ROACH A 2091 ROACH B 2093 LECRON 5A 2094 LECRON 5B 2095 VEHE A 2096 VEHE B 2097 A7 2098 B7 2099 WARD 2-A 2100 WARD 2-B



P.K. THOMAS

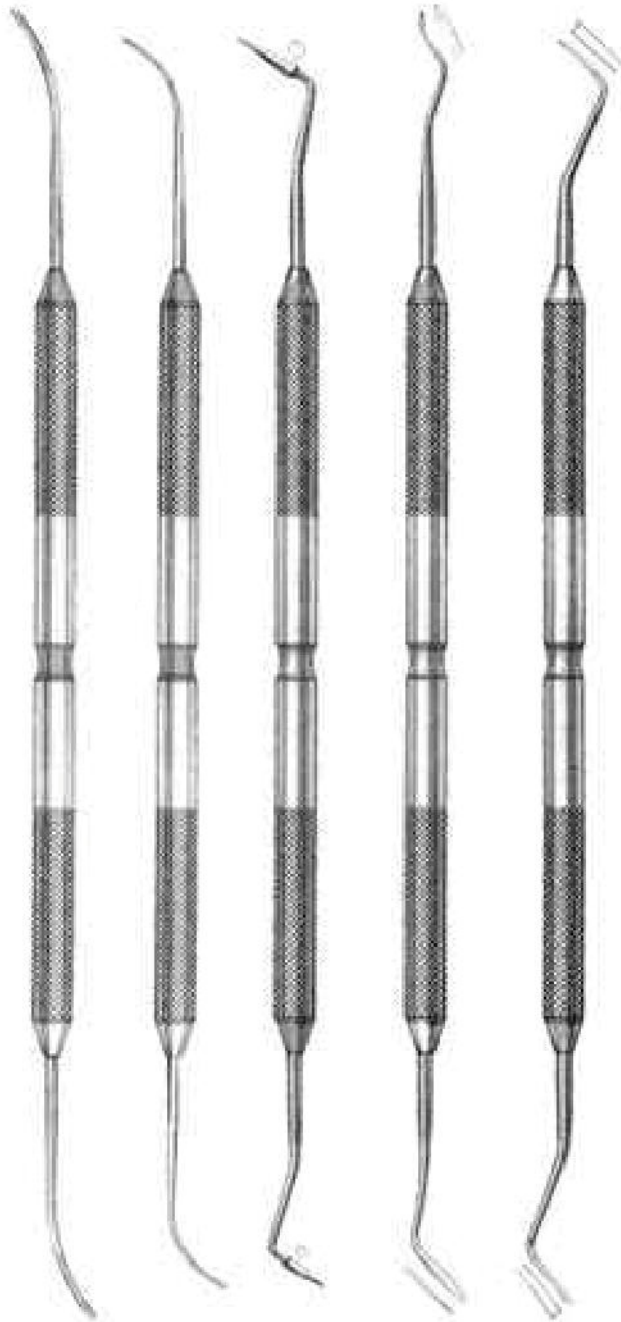

- 2101 PKT1
- 2102 PKT2
- 2103 PKT3
- 2104 PKT4
- 2105 PKT5

Set of 5 Instruments

WAX CARVERS

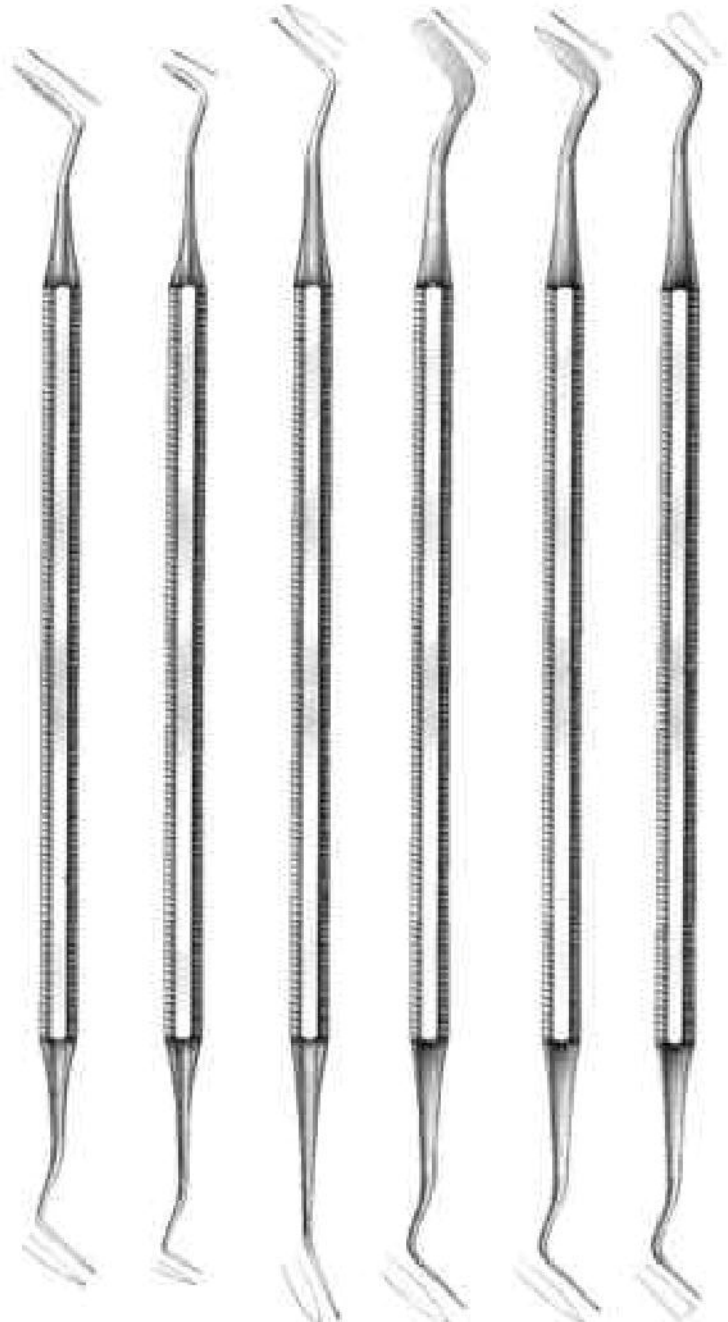

- 2106 Hollenback 3
- 2107 Hollenback 3S
- 2108 WARD 1
- 2109 WARD 2
- 2110 WALL 1
- 2111 WALL 3



**Wax, Modeling Carvers
Cement Spatulas**

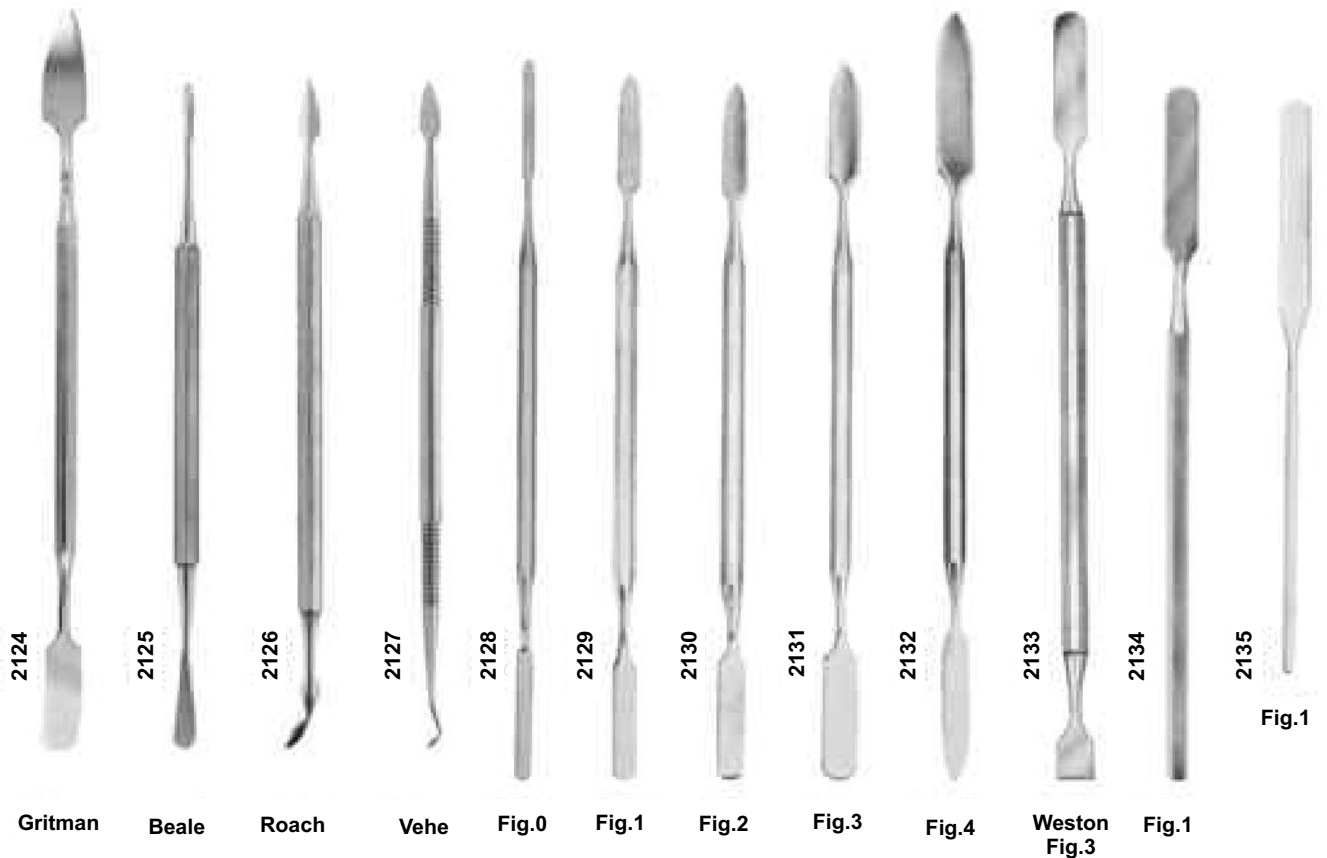
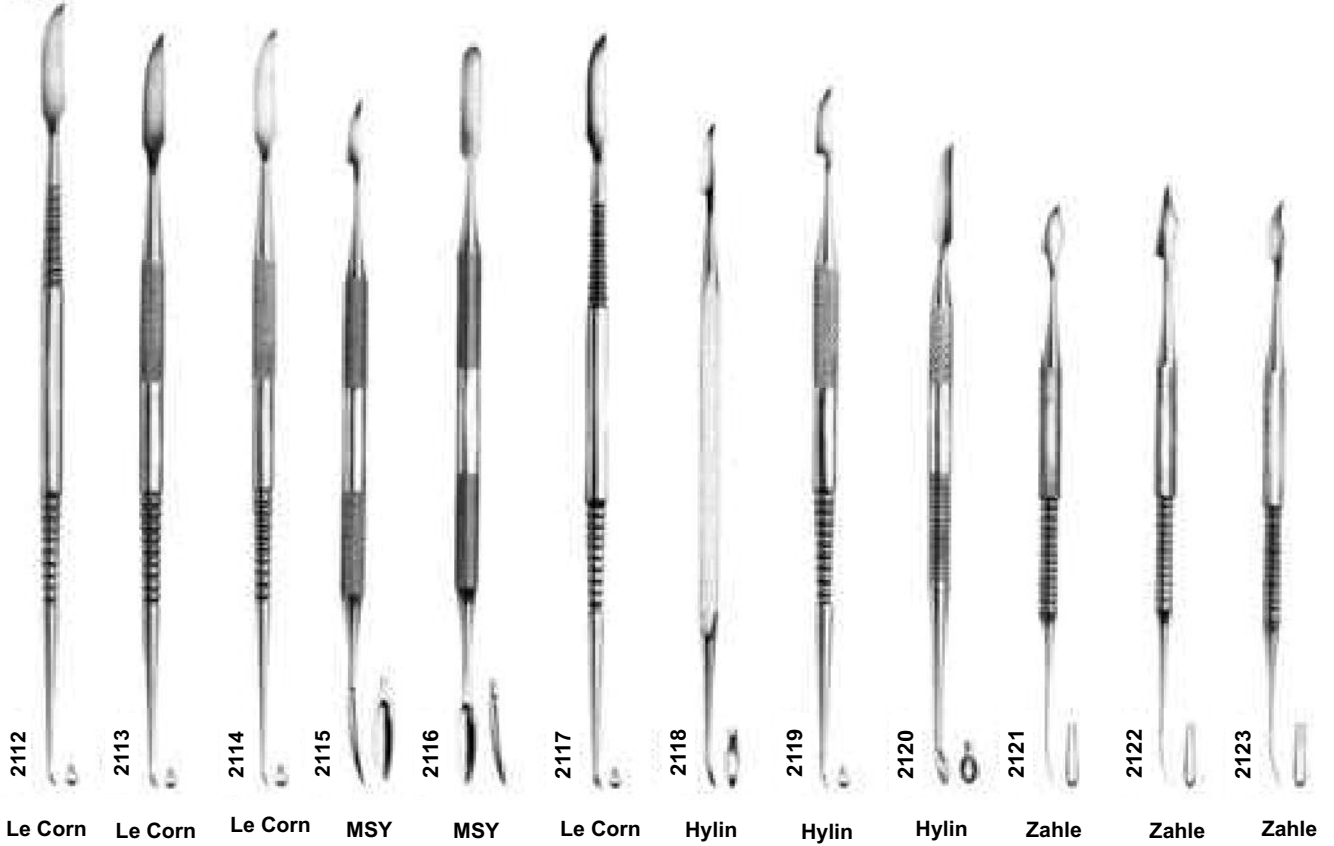

Fig.1



Wax, Porcelain & Cement Instruments

WAX & PORCELAIN CARVERS



2136
LECRON
Inlay

2137
REEVES

2138
VEHE
Wax

2139
ROACH
Wax

WAX SPATULAS



2140
W-31

2141
W-5

2142
W-7

2143
W-7A

2144
W-7G



Cement Spatulas



2145
AGATHE



2146
C-7



2147
C-5



2148
C-313



2149
C-24A Rigid



2150
C-24 Flexible



2151
C-24 Flexible



2152
24



2153
A6



2154
7 Wax



2155
26



2156
All Metal Spatulas With High Polish
Stainless Steel Blade

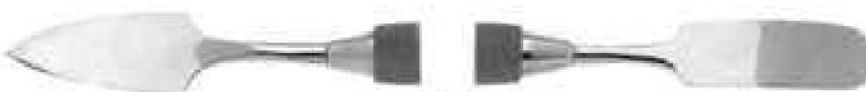

2157
31



Spatulas





Spatulas



2164
Fig. 7
10.5 cm

2165
Fig. 8
20 cm

2166
Fig. 9
22.5 cm



Files, Hoes & Knives

FILES



2167
Hirshfeld 3-7



2168
Hirshfeld 5-11

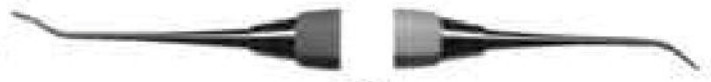

2169
Hirshfeld 9-10



2170
Orban 10-11

HOES



2171
Orban 6-7



2172
Orban 8-9

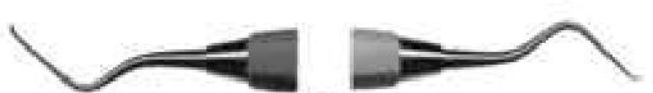

2173
UWH 16-18



2174
UWH 16-18



2175
UWH 20-21

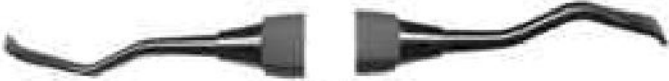

2176

KNIVES



2177
Orban Knife 1-2



2178
1 SE

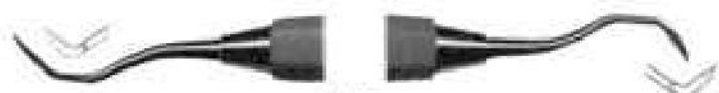

2179
2-3



2180
Krikland 13-13L

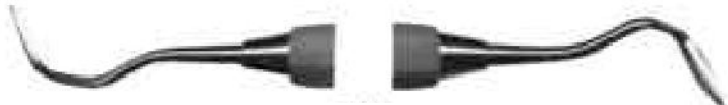

2181
Knife Orban 1-2 TT Deo13-13L



Wax Knives



2182
Fahnenstock
Fig. 1
12.5cm

2183
Fahnenstock
Fig. 2
17cm

2184
Lessman
Fig. 1
12.5cm

2185
Lessman
Fig. 2
17cm

2186
Con scodellino
Fig. 1
12.5 cm

2187
Con scodellino
Fig. 2
17 cm

2188
Emert

2189
Emert



Wax Knives & Plaster Knives



2190
18cm



2191
18cm



2192
17cm



2193
17cm



2194
Fig1
17cm



2195
22 cm



2196
22 cm



2197
Gritman
Fig 3
17 cm



2198
Fig 3
16 cm



2199
Fig 4
16 cm



Crane-Kaplan, Chisels

CRANE-KAPLAN



2200
Ck1
Pocket Marker

2201
Ck2
Pocket Marker

2202
Knife

2203
Dissector

2204
Scaler

OCHSENBEIN



2205
Ochsenbein
Fig 1

2206
Ochsenbein
Fig 2

2207
Ochsenbein
Fig 4



Split Chisel Set



2208
Split Chisel
6mm Curved



2209
Split Chisel
6mm Straight



2210
Split Chisel
4mm Curved



2211
Split Chisel
4mm Straight



Bone Currettes

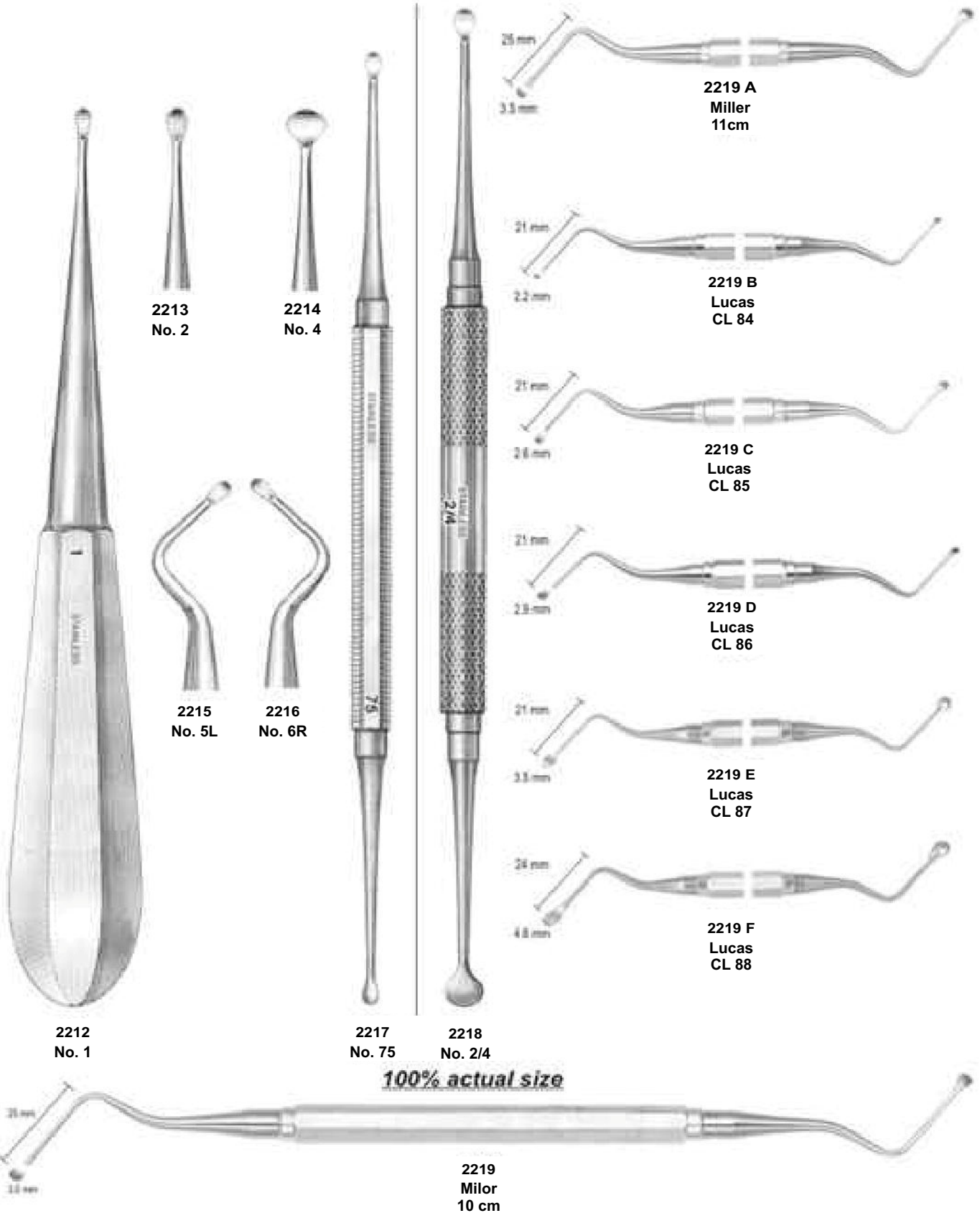



Bone Files

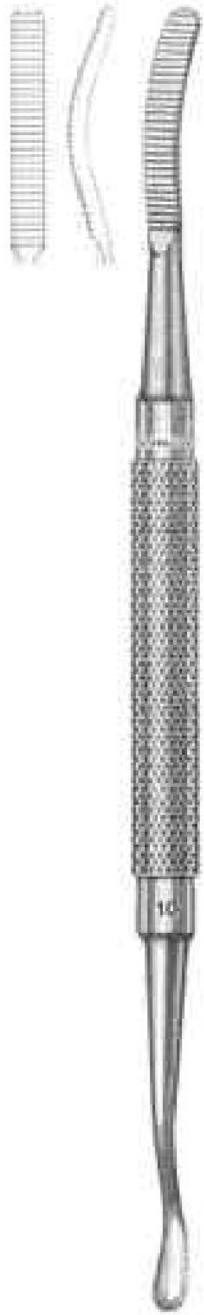

2220
No. 10

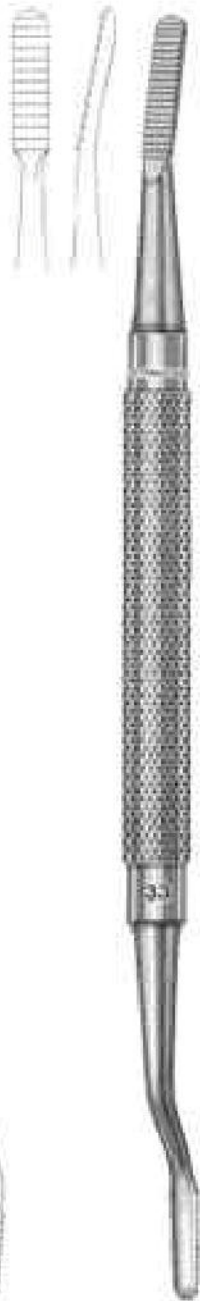

2221
No. 33

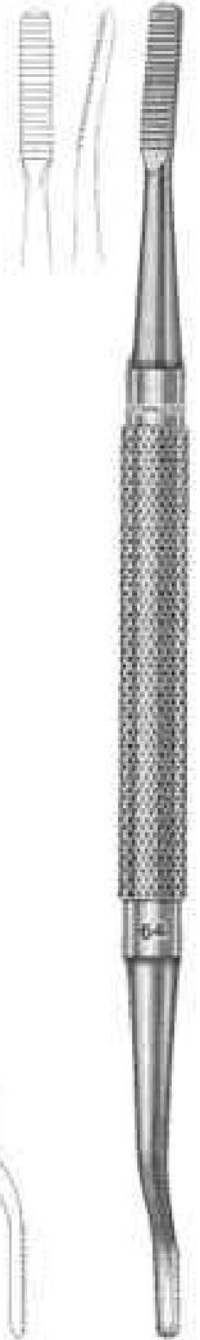

2222
MILLER
No. 33

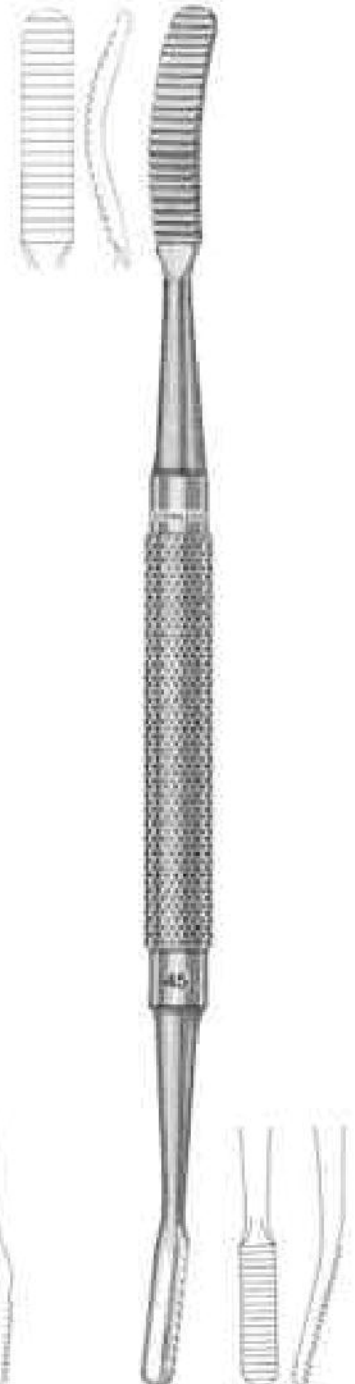

2223
MILLER
No. 64



Bone Files

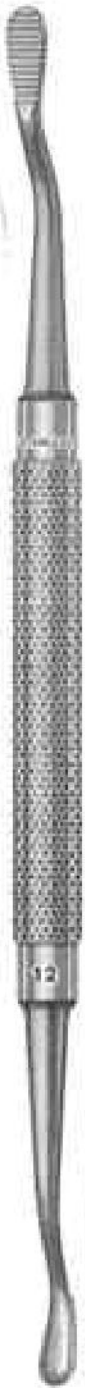
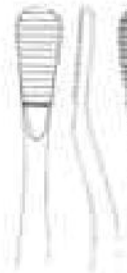

2224
HOWARD
NO. 12



2225
HOWARD
NO. 12A

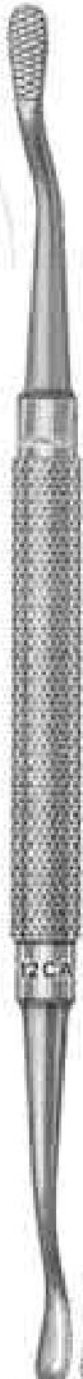

2226
HOWARD
NO. 12CA

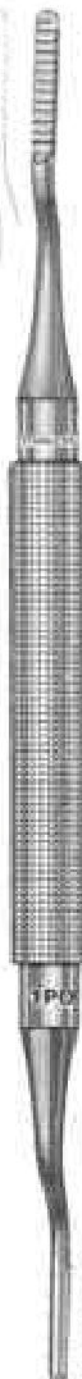

2227
POLOKOFF
NO. 1





Bone Chisels

GARDNER



2228
GARDNER
No. 1

2229
GARDNER
No. 2

2230
GARDNER
No. 5

2231
GARDNER
No. 5R

WAKEFIELD



2232
WAKEFIELD
No. 1W

2233
WAKEFIELD
No. 2W



Bone Chisels Bone Mallets

Bone Chisels and Gouges

 2234 3mm 2235 4mm 2236 5mm 2237 6mm PARTSCH 13.5cm	 2238 3mm 2239 4mm 2240 5mm 2241 6mm PARTSCH 13.5cm	 2242 3mm 2243 4mm 2244 5mm 2245 6mm PARTSCH 17cm	 2246 3mm 2247 4mm 2248 5mm 2249 6mm PARTSCH 17cm	 2250 3.5mm 16cm Winlliger	 2251 7mm 16cm Winlliger	 2252 5mm 16cm Winlliger	 2253 5mm 16cm Winlliger
--	--	--	--	--	--	--	--

Martelli chirurgici Mallet

 Lead filled 2254 PARTSCH 19cm	 Non autoclavable plastips 17cm 2255 Non autoclavable plastips 17cm	 Non autoclavable plastic inserts 2256 MEAD 19.5cm	 Autoclavable plastic tips 16.5cm 2257 AUTOCLAVABLE PLASTIC TIPS 16.5cm	 With interchangeable Ferrozeel faces 2258 MEAD 17cm
--	---	---	---	---



Crown Removers



2259



2263
Crown Spreader, Crown Remove

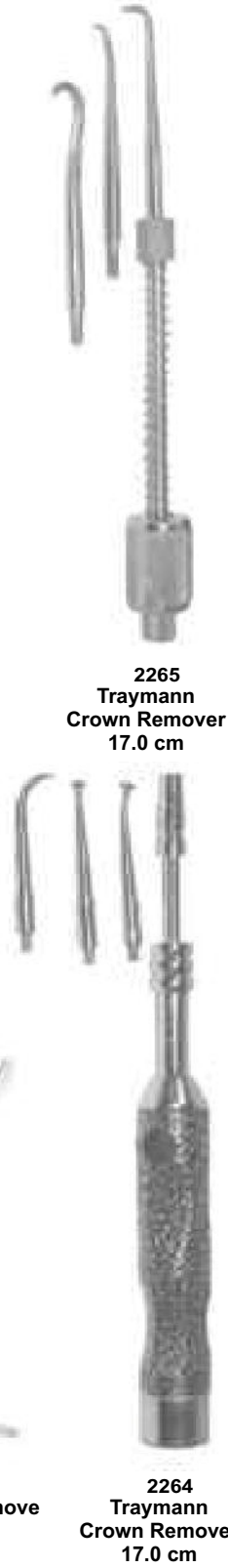

2265
Traymann
Crown Remover
17.0 cm

2264
Traymann
Crown Remover
17.0 cm

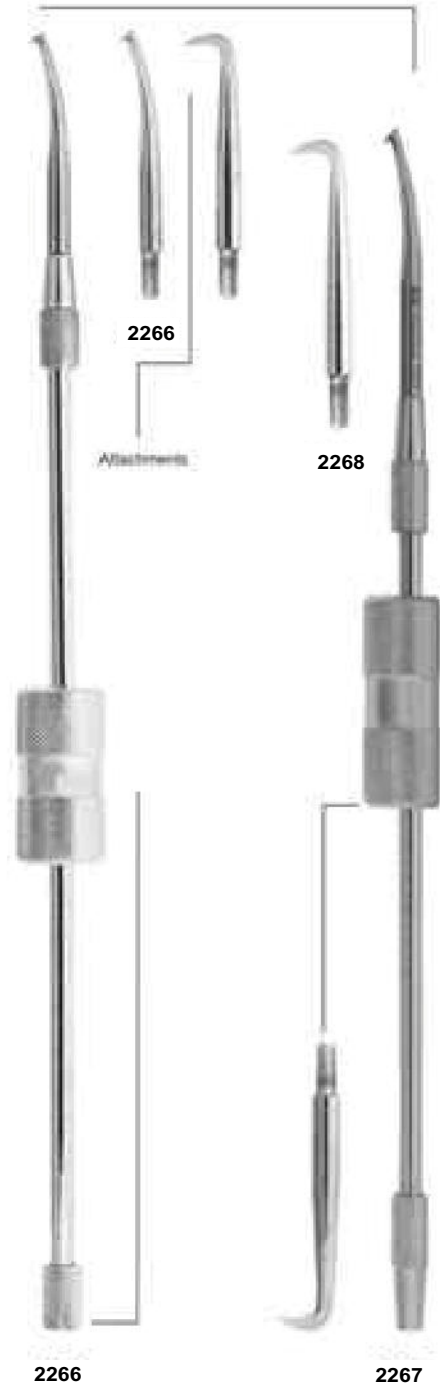

2266

2267



Crown Instruments



2269 Crown Remover

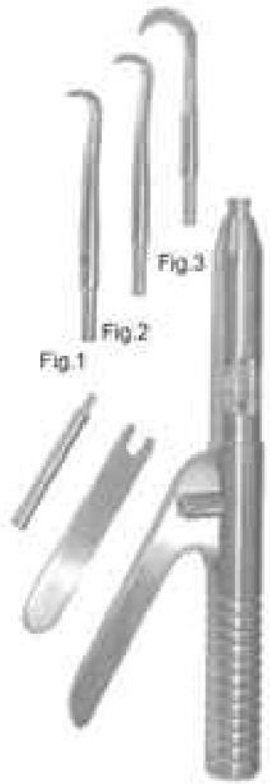

2270 Crown Remover



2271 Single loop with adapter

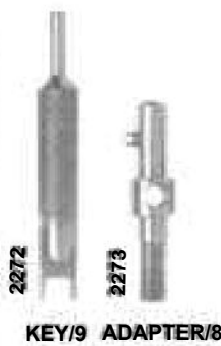

2272 KEY/9 ADAPTER/8



2274 Crown & Bridge Holding Forceps With Support Ring



2275 WYNMAN Crown Gripper, CARB N SERT



2276 Crown Opener

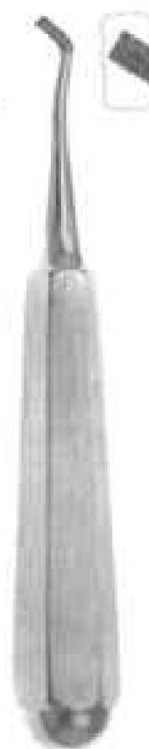

2277 Mershon 14.5cm



2278 Universal Hollow Handle

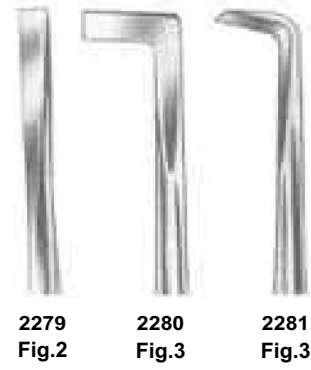

2279 Fig.2

2280 Fig.3

2281 Fig.3





Crown Instruments



2282
Plaster Shear
210mm



2283
Crown Removing Plier
14 cm



2284
MONTFORT
18 cm



2285
BOHM
16 cm



2286
Telescope Crown
Plier Diamond coated
13 cm



2287
Telescope Crown
Plier Diamond coated
13 cm

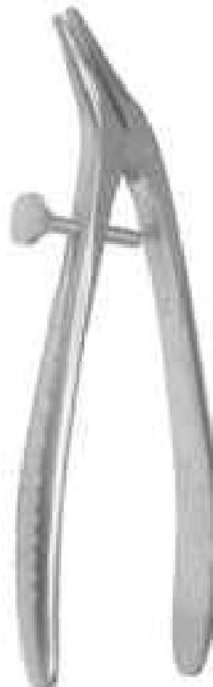

2288
Telescope Crown Plier
13 cm gerieften Maul
15 cm gerieften Maul
13 cm gelatts Maul
15 cm gelatts Maul



2289
Telescope Crown
Plier Fine
15.0 cm



Implants Instruments



2290
1P
150 mm



2291
Fig1
155 mm

Ø 2 mm



1P
150 mm

Ø 2.7 mm



2P
150 mm

Ø 3.25 mm



3P
150 mm

Ø 3.8 mm

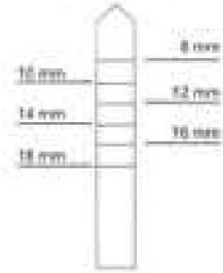

4P
150 mm

Ø 3 mm



1T
150 mm

Ø 4 mm



2T
150 mm

Ø 5 mm



3T
150 mm

Ø 1.60 mm



1
155 mm

Ø 1.90 mm



2
155 mm

Ø 2.80 mm



3
155 mm



4
155 mm



5
155 mm



6
155 mm



Implants Instruments



2292
Fig1B
165 mm

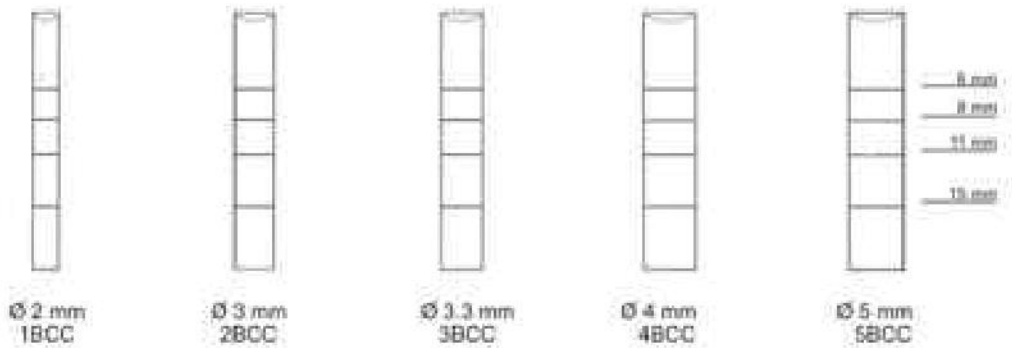
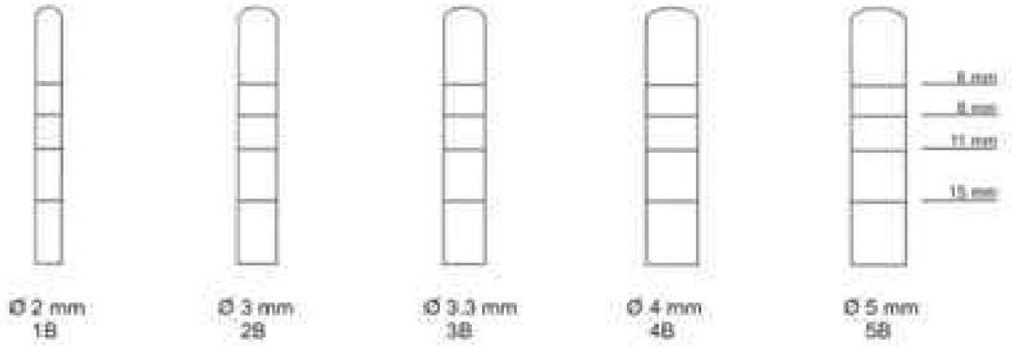

2293
Fig1
155 mm

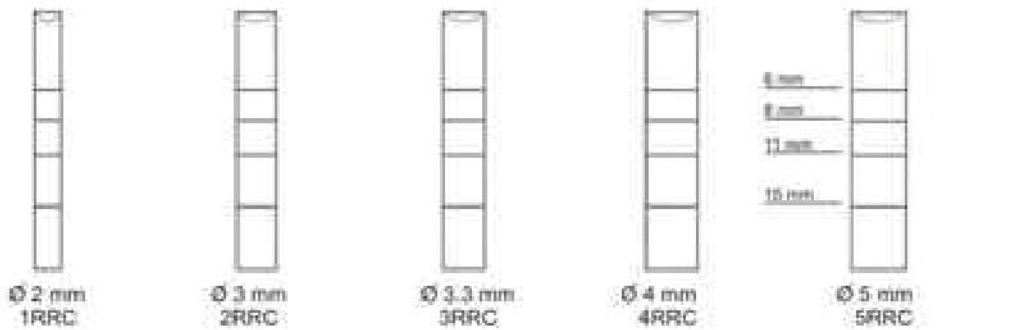
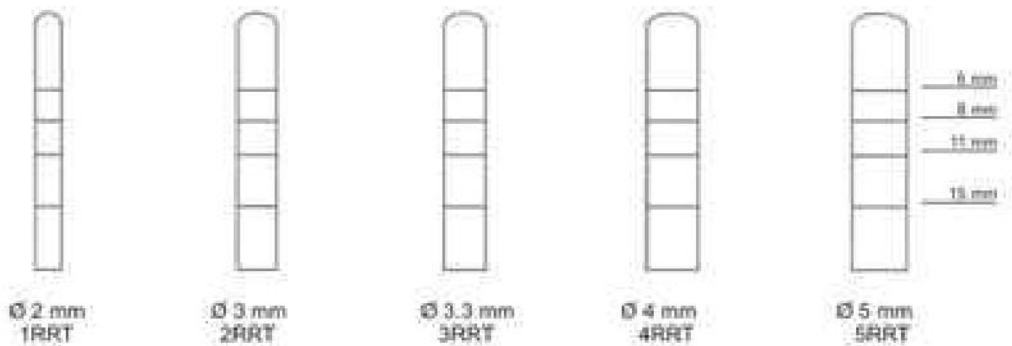



Implants Instruments

Endo guns for retrograds.

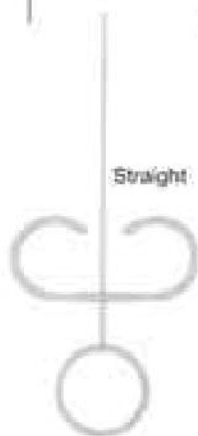

2294
DYE 1.2 mm
130 mm

Ø 1.2 mm
Curved
Carry any mixed materials to perforations, apical or difficulty to access sites.



2295
DYE 1.8 mm
130 mm

Curved



Concave

Beveled

Bone Injectors



2296
DYE 2.5 mm
150 mm

2297
DYE 4.4 mm
150 mm

2298
DYE 7 mm
150 mm



2299
DYE 2.5 mm
150 mm



2300
DYE 4.4 mm
150 mm



Bone wall

2301
DYE 35 mm
H 35 mm



2302
Grinders for autogenius



2303
Bone Mill forcep
17.0cm



**Suction tubes, Bone Pluggers
Rongeurs**

Suction Tubes



2304

2305

2306

Bone Pluggers



Kerrison Rongeurs



(1.5 mm inside) 2311
 (2.0 mm inside) 2312
 (3.0 mm inside) 2313
 (4.0 mm inside) 2314
 (4.5 mm inside) 2315
 16.5 cm

(1.0 mm inside) 2316
 (2.0 mm inside) 2317
 (2.5 mm inside) 2318
 16.5 cm



Implants Instruments



2319
Fig. 1
170mm

2320
Fig. 2
175mm

2321
Fig. 3
170mm

2322
LUCAS
Fig. 88
170mm



Bone Compactors

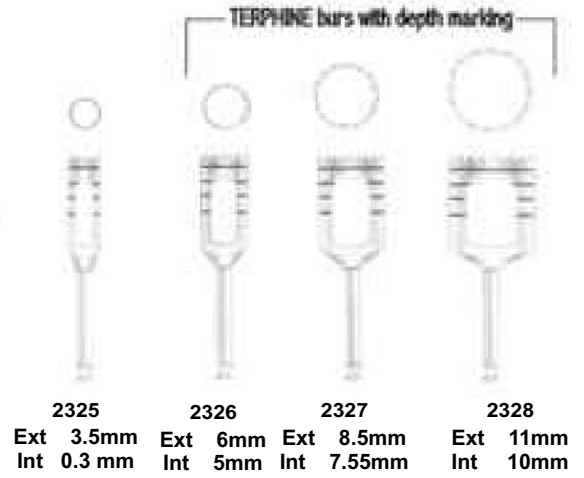

2325	2326	2327	2328
Ext 3.5mm	Ext 6mm	Ext 8.5mm	Ext 11mm
Int 0.3 mm	Int 5mm	Int 7.55mm	Int 10mm

Sinus lift instruments



2329
Fig. 1

2330
Fig. 2

2331
Fig. 3

2332
Fig. 4

2333
Fig. 5

2334
Fig. 6











2335
Fig. 7

2336
Fig. 8

2337
Fig. 9



Suction Tubes

- 
Canula, Curved 2338
- 
Canula, Curved 2339
- 
Canula, Curved 2340
- 
Canula, Curved 2341
- 
Canula, Straight 2342
- 
Canula, Curved 2343
- 
Canula, Curved 2344
- 
Canula, Curved 2345
- 
Canula, Curved 2346
- 
Canula, Curved 2347
3.0mm A
4.0mm B
5.0mm C

2.0 mm
3.0 mm
4.0 mm

2.0 mm
3.0 mm
4.0 mm

Section - 05

- * Measuring Instruments
- * Amalgam Guns & Carriers
- * Retainers
- * Rubber Dam Instruments
- * Syringes * Tweezers
- * Sterilizing & Lab. Instruments





Measuring Instruments



2348
BOLEY Guage



2349
ZURICHER
130mm

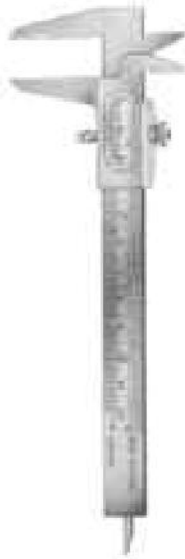

2350
VERNIER
12cm



2351
VERNIER



2352
VERNIER Guage



2353
VERNIER Guage



2355
Finger Ruler



2354
LAWANSON
Crown Guage

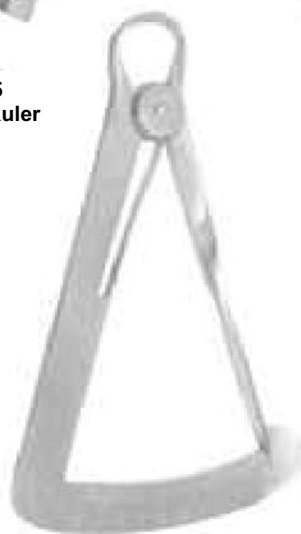

2356
LAWANSON
Crown Guage



2357
Spring Guage
10 cm



2358
Spring Bow Divider
6" Radius

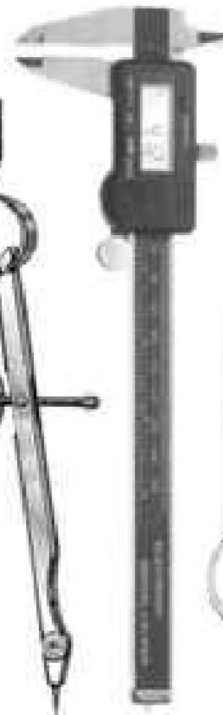

2359
VERNIER
Guage



2360
ALBEE



2361
Height Guage
Wick Type



Bone Gauge & Measuring Instruments



2362 Bone Gauge



2363 Bone Calliper 15cm



2364 Casterviejo



2365 B Straight



2365 A Casterviejo Curved

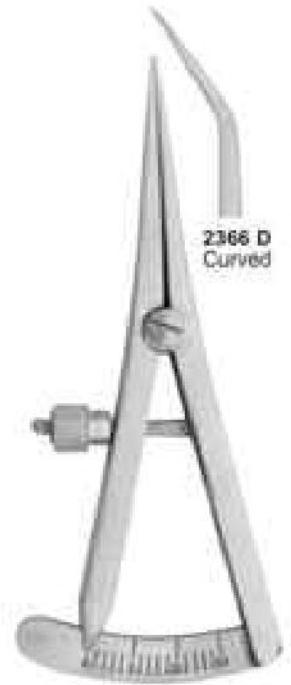

2366 D Curved

2366 C Casterviejo Straight



2367 Guage

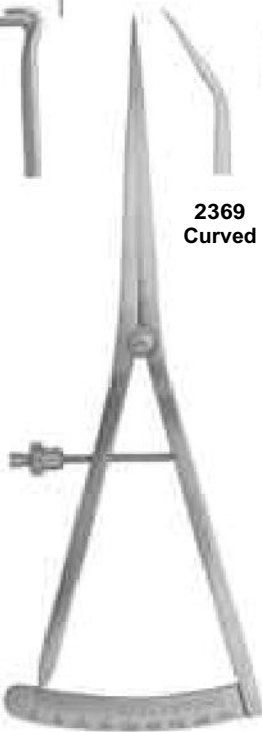

2368 Castroviejo Straight

2369 Curved

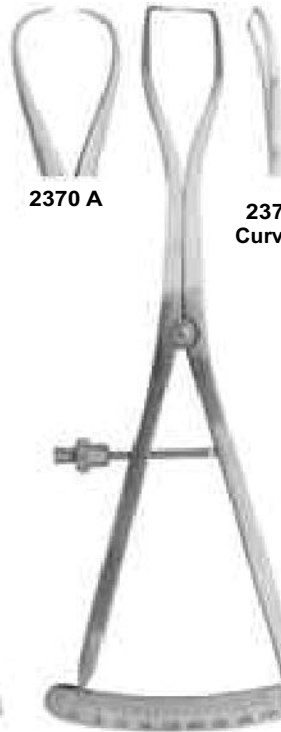

2370 Castroviejo Straight

2370 A

2371 Curved



2373 BOOne Guage

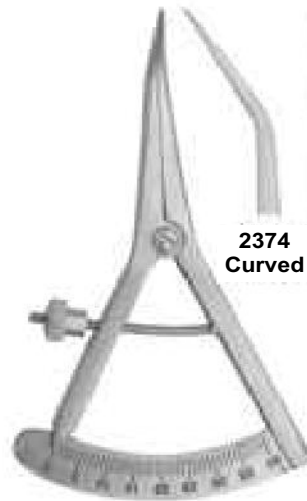

2372 Castroviejo

2374 Curved 2375 Straight



2376 Bracket Guage, Ant /Post



Amalgam Guns & Carriers



2377
Medium Large
20cm



2378
Medium Jumbo
20cm



2379
Large Jumbo
20cm



2380
Jumbo Jumbo
20cm



2381
Regular Jumbo
Silicon Grip
20cm



2382
Medium
15.5cm



2383
Large
15.5cm



2384
Jumbo
15.5cm



2385
145mm

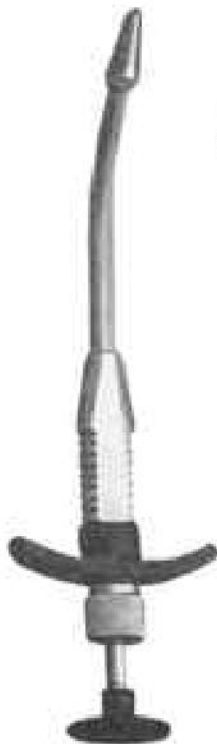

2386
130mm



2387
Straight
15cm

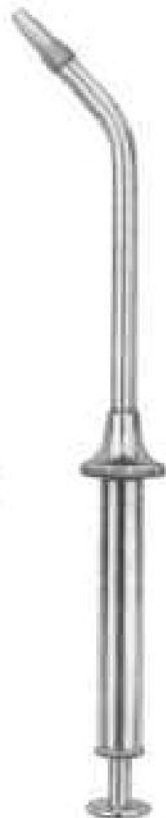

2388
15 cm



2389
15 cm



2390
Amalgam Well
Non stick Base
3.5mm



**Retainers, Bands, Strip Holder Clips,
Napkin Holder**

Retainers



2391
No. 1

2392
No. 8

2393
No. 9

"Tofflemire" Type Retainers



2394
SENIOR CA

2395
SENIOR CA

2396
UNIVERSAL

Tofflemire Bands

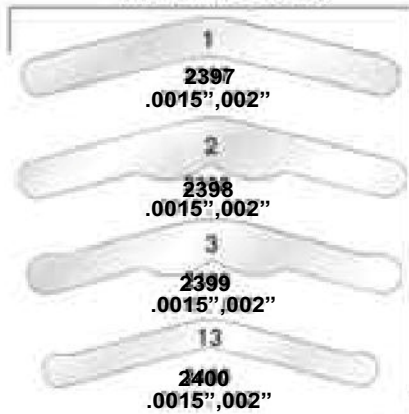

2397
.0015", .002"

2398
.0015", .002"

2399
.0015", .002"

2400
.0015", .002"

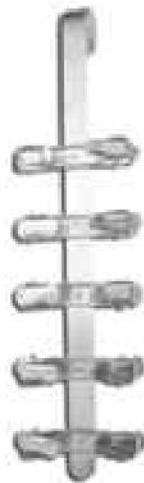

Set of 10
2402
Film Hanger

Napkin Holders



2403
BALL CHAIN

2404
NON CHILL
Clear Plastic

2401
X-Ray Holder
Small



Strip Holders



2408
Strip Holder Clip
90 D

2409
Strip Holder Clip
45 D

2405
Finger Protector
Small

2406
Medium

2407
Large



Rubber Dam Instruments



**2410
IVORY
Leight Weight 170mm**



**2411
BREWER
175mm**

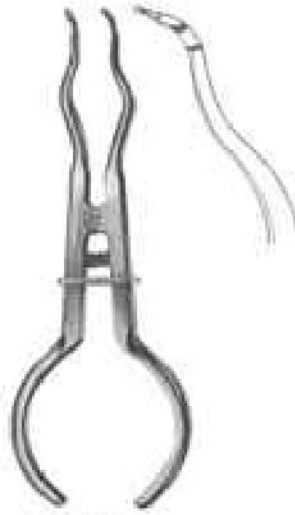

**2412
BREWER
175mm**



**2413
WHITE
175mm**

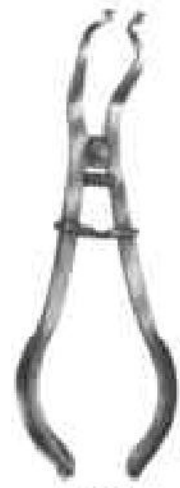

**2414
IVORY
170mm**



**2415
AINSWORTH
Rubber Dam Punch
170mm**



**2416
AINSWORTH
Rubber Dam Punch
170mm**



**2417
AINSWORTH
Rubber Dam Punch
170mm**

Articulating Paper Forceps



**2421
MILLER
Articulating
Forceps
15cm**

**2422
MILLER
Articulating
Forceps
15cm**

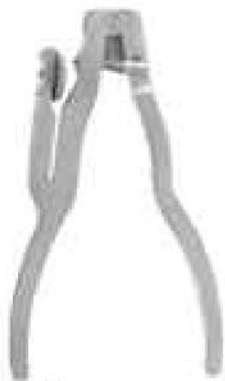

**2418
Plastic Rubber Punch
160mm**



**2419
Plastic Rubber Dam
Frame 242**

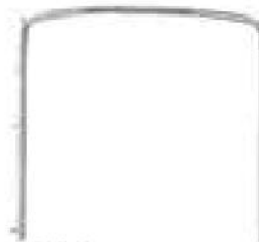

**2420
Rubber Dam Holder
Stainless Steel**



Rubber Dam Clamps

LOWER MOLARS



2423 76D-W3 2424 76D-3



2429 76D-7A 2430 76D-7



2435 76D-12A 2436 76D-13A



2441 76D-26 2442 76D-28



2445 76D-W8A 2446 76D-8A



2447 76D-10 2448 76D-11



2451 76D-24 2452 76D-25

UPPER MOLARS



2425 76D-4 2426 76D-5



2431 76D-8 2432 76D-26N



2437 76D-30 2438 76D-31



2443 76D-201 2444 205

MOLARS



2449 76D-14 2450 76D-118

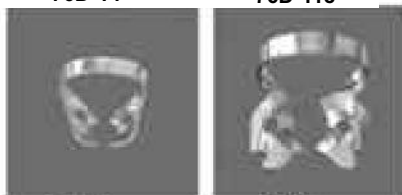

2453 76D-27 2454 76D-56



2455 76D-14A

PREMOLARS

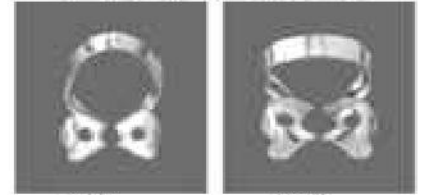

2427 76D-0 2428 76D-1



2433 76D-2A 2434 76D-2

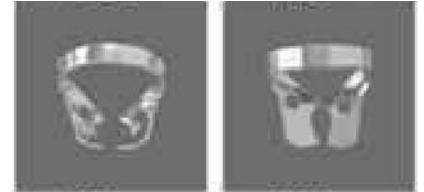

2439 76D-27N 2440 76D-29

ANTERIOR

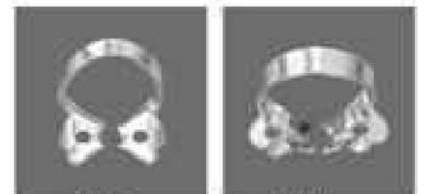

2456 76D-00 2457 76D-1A



2458 76D-9 2459 76D-212



Aspirating Syringes

4969/CO



4969/F



4969/CV

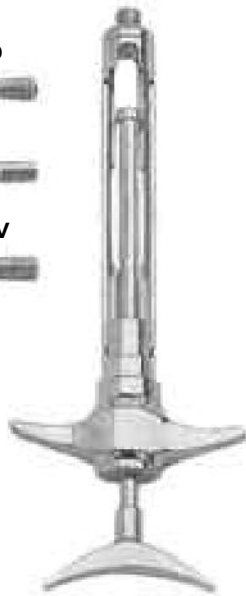

2460
MI 1.8
EU



2461
MI 1.8
EU/AM



2462
MI 1.8
EU/AM



2463
Fig.1
MI 1.8
EU



2464
Fig.1
MI 1.8
EU



2465
SS INOX
All Inox & autoclavable
black plastic handle
passive automatic aspiration



2466
Fig. 1
ml 1.8
EU/Am



2467
Fig. 1
ml 1.8
EU/Am



2468
Fig. 1
ml 1.8
EU/Am



2469
MI 1,2
EU/Am



Syringes



2470
Water Syringe
Complete with 1
cannula(luer-lock)



2471
Water Syringe
Complete with 1
cannula(luer-lock)

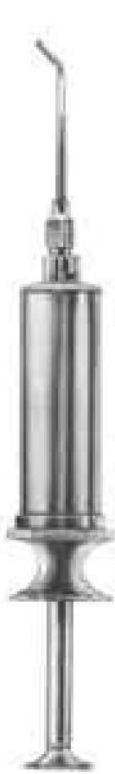

2472
Metal water Syringe
Self filling with 1
cannula(luer-lock)



2473
Sparrel Barrel with
Plunger suitable for syringes



2475
Articulating
Barrel Syringe



2474
Cannula, only with
Luer-Connector
Suitable for syringes



2476
MI 1.8



2477
MI 1.8



2478



2479



2480



2485
Fig.1
MI 1.8 EU



2481
Fig.1
ml 1.8EU



2482
Water
point



2483
Water
point



2484
Water
point



Dental Tweezers



**2486
ADSON**
Curved 14cm



**2487
ADSON**
1x2/12cm



**2488
ADSON**
12cm



**2489
MICRO ADSON**
15cm



**2490
Standard**
14,18,25cm



**2491
Cushing**
18cm



**2492
Curved**



**2493
SELECT**
15,18,20cm



2494



**2495
MCINDOE**
15cm



**2496
GILLIES**
15cm



**2497
WAUGH**
15,20cm



**2498
PERRY**
13cm

Serrated



**2499
KOPP**
15.5cm



Dental Tweezers



2500
COLLEGE
15cm



smooth



2501
COLLEGE
15cm



serrated



2502
COLLEGE
15cm



smooth



2503
COLLEGE
15cm



serrated



2504
COLLEGE
15cm



smooth



2505
COLLEGE
15cm

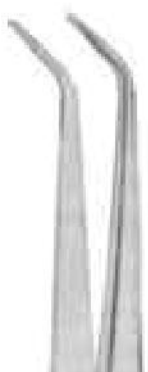

serrated



2506
COLLEGE
15cm



smooth



2507
COLLEGE
15cm



serrated



Dental Tweezers



2508
MERIAM
16cm



smooth



2509
MERIAM
16cm



serrated



2510
MERIAM
16cm



smooth



2511
MERIAM
16cm



serrated



2512
MERIAM
16cm



smooth



2513
MERIAM
16cm



serrated



2514
MERIAM
16cm



smooth



2515
MERIAM
16cm

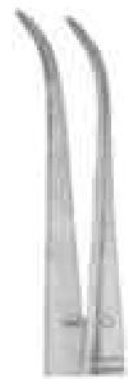

serrated



Dental Tweezers

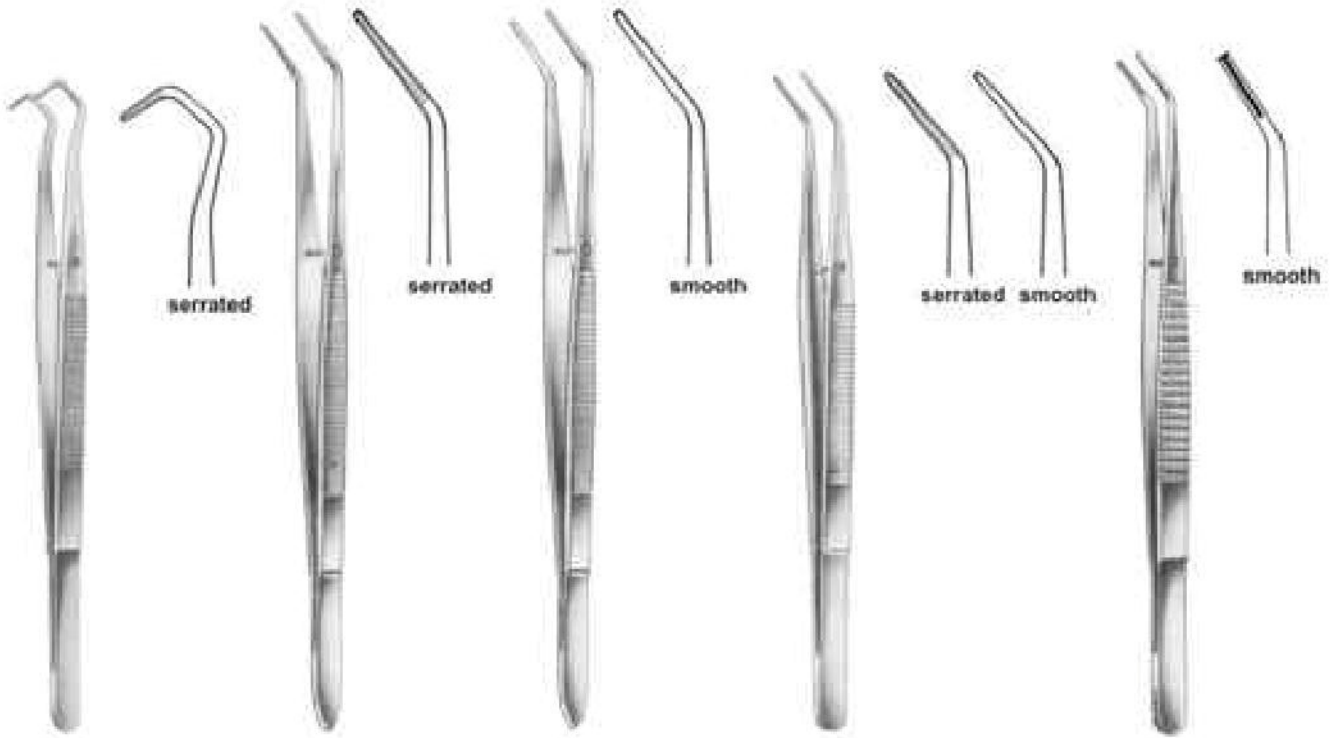

2516
COLLEGE
14.5cm

2517
FLAGG
16cm

2518
FLAGG
16cm

2519
LANDGRAM
15cm

2520
15cm

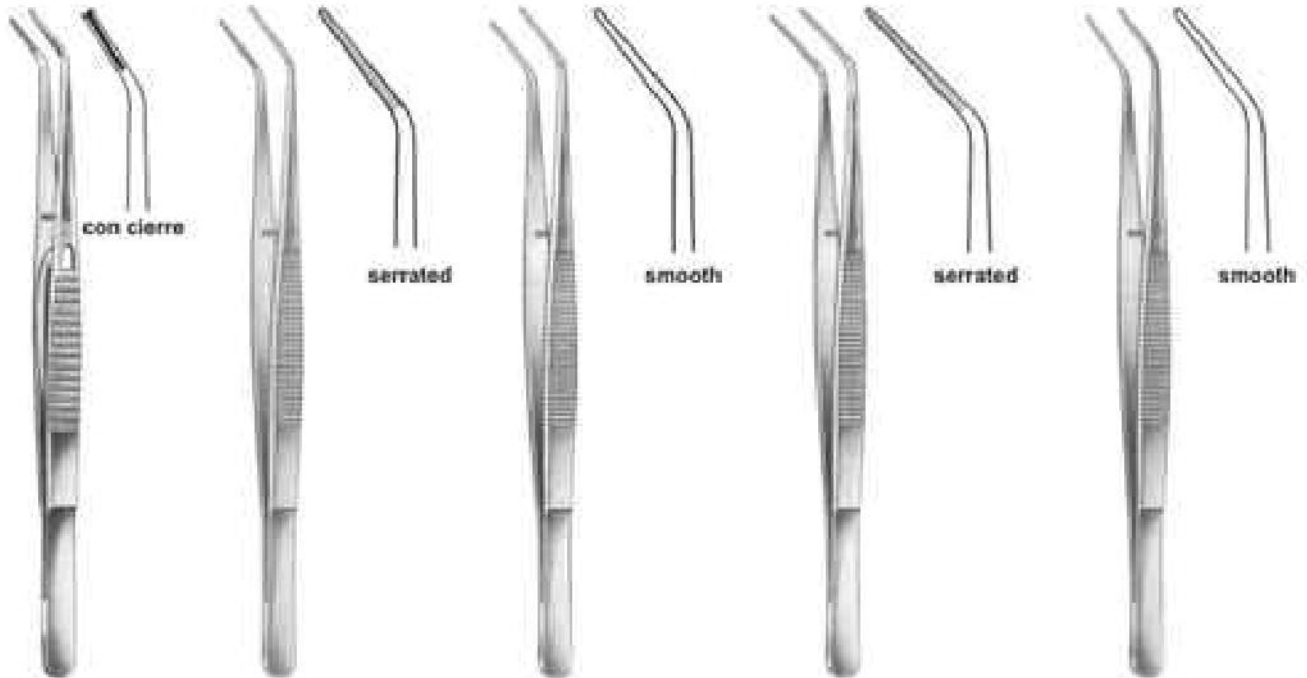

2521
15cm

2522
LONDON-COLLEGE
15cm

2523
LONDON-COLLEGE
15cm

2524
LONDON-COLLEGE
15cm

2525
LONDON-COLLEGE
15cm



Dental Tweezers



2526
LONDON-COLLEGE
15cm



2527
LONDON-COLLEGE
15cm



2528
MERIAM
16cm

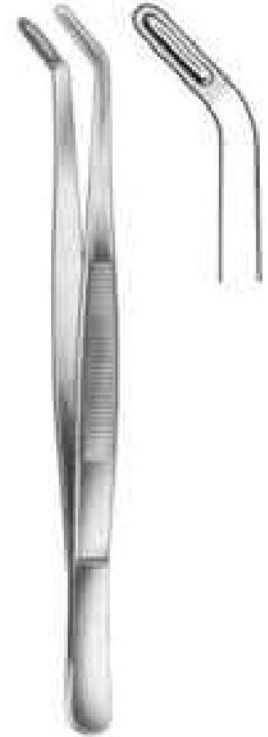

2529
ALLEN
18cm



2530
ALBRECHT
16cm



2531
ALBRECHT
16cm



2532
16cm



2533
16cm



2534
16cm





Strilizing & Lab Instruments



2535
DAVIS
6"



2536
GRASPING FORCEPS
6 1/4"



2537
MESH BUR &
DIAMOND HOLDER
LARGE 2 1/8" D



2538
Soldering Tweezer
6 1/4"



2539
Narrow Fine
4 3/4"



2540
Super Fine
4 3/8"



2541
Fine Curved
4 1/2"



2542
Bonding Bracket
Holder 136mm



2543
Bonding Bracket
Holder 135mm



2544
Bonding Bracket
Holder 135mm



2545
Bonding Bracket
Holder 140mm

Section - 06

- * Endodontic Forceps
- * Tissue Forceps
- * Retractors
- * Mouth Gags

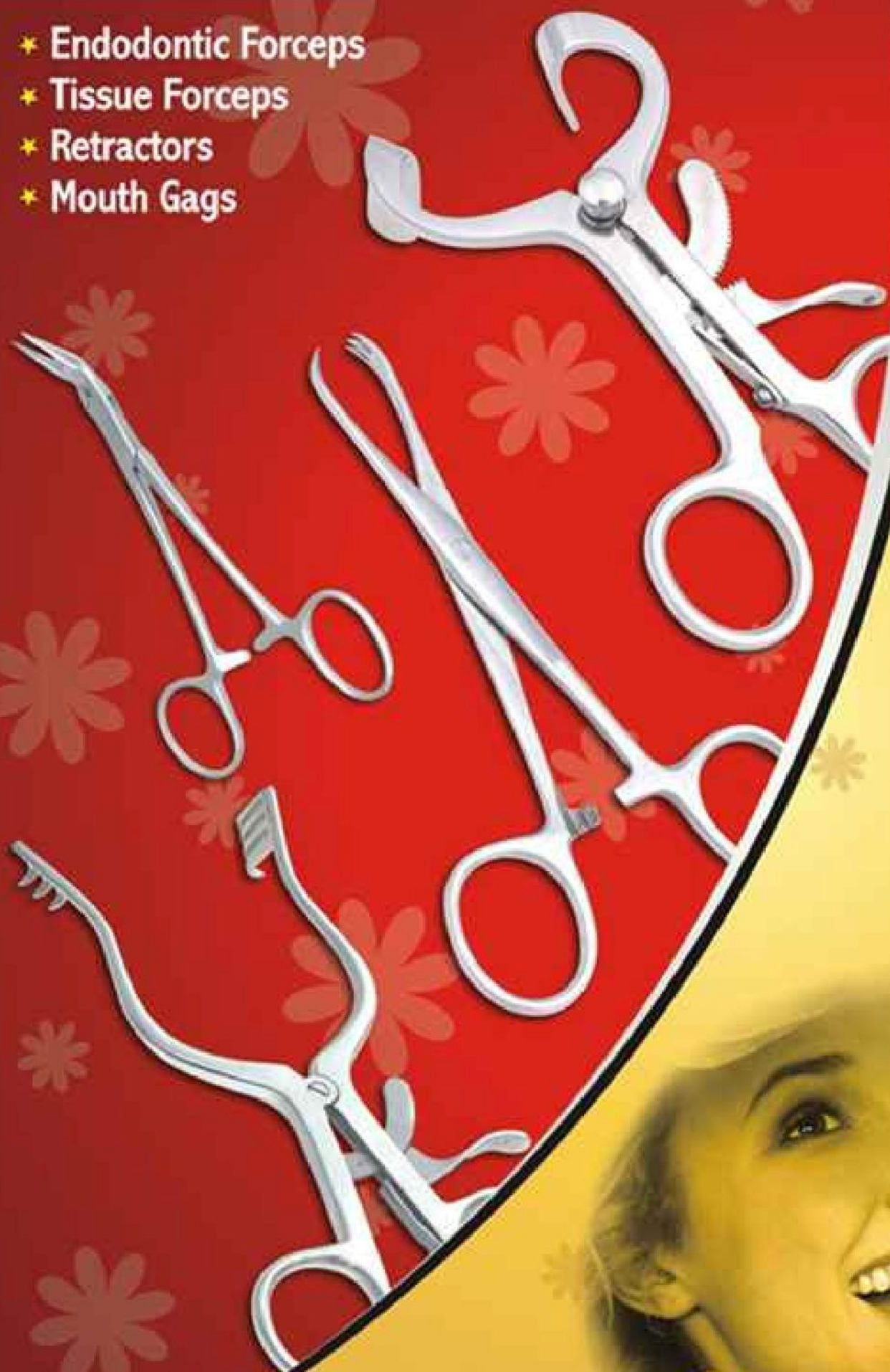



Endodontic Forceps



2546
Endo Forceps
4 3/4"



2547
PEETS Forceps
4 3/4"

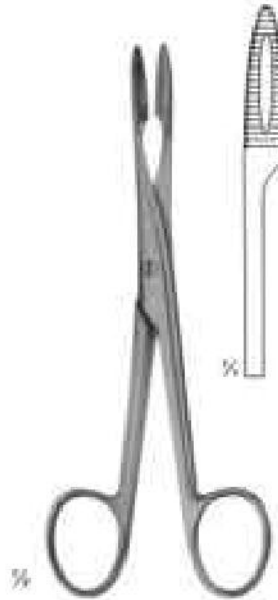

2548
Without Ratchet
145mm

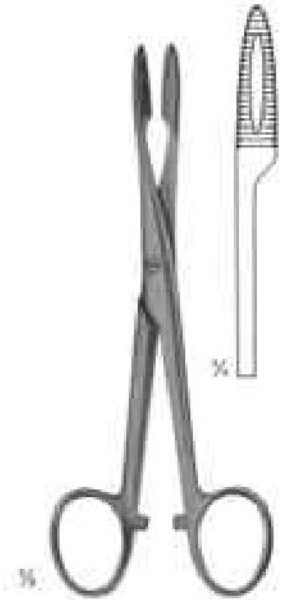

2549
With Ratchet
145mm



2550
CRILE
140mm

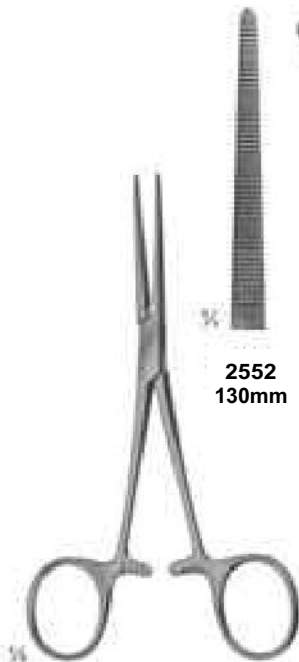

2551
PEAN
SLENDER TYPE

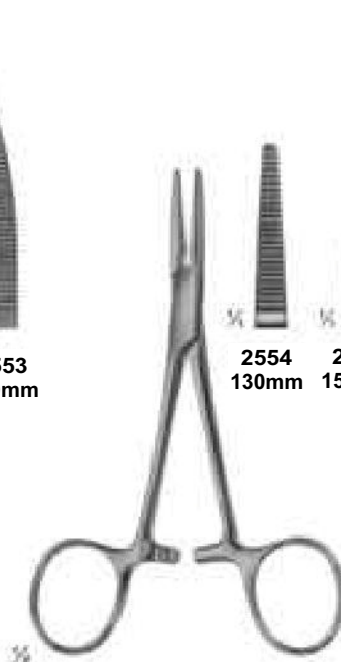

2554
SPENCER WELLS



2552
130mm



2553
140mm



2554
130mm



2555
150mm



2556
130mm



2557
150mm



Tissue Forceps



2558
BABY Allis
5" Straight
4x5 Teeth extra delicates



2559
Allis
6" Straight
4x5 Teeth extra delicates



2560
Allis
6" Straight
4x5 Teeth extra delicates

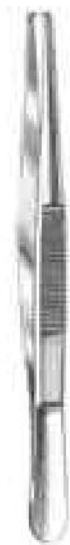

2561
1x2 Teeth
6"



2562
SEMKIN
1x2 Teeth
6"



2563
ADSON
1x2 Teeth
4 3/4"



2564
BROWN-ADSON
7x7 Teeth
4 3/4"



2565
BROWN
8x8 Teeth
6"



2566
RUSSIAN
8x8 Teeth
6"

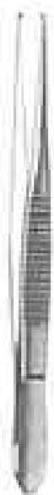

2567
EXTRA Delicate
Straight 4"
1x2 Teeth



**Hemostatic Forceps Forceps
Towel Clamps, Napkin Holder**



2568
HALSTED MOSQUITO
Straight. Curved 5"



2569
HALSTED MOSQUITO
Straight. Curved 5"
1x2 Teeth



2570
HALSTED MOSQUITO
Jaws 45 Angled on Flat 5"
Extra Delicate

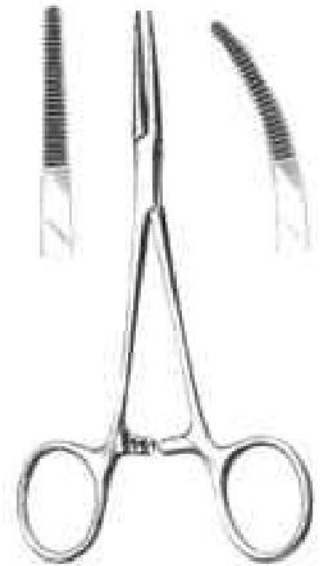

2571
KELLY
5 1/2" Straight



2572
JONES
3 1/2"



2573
BACKHUAS
3 1/2"



2574
BACKHUAS
5 1/4"

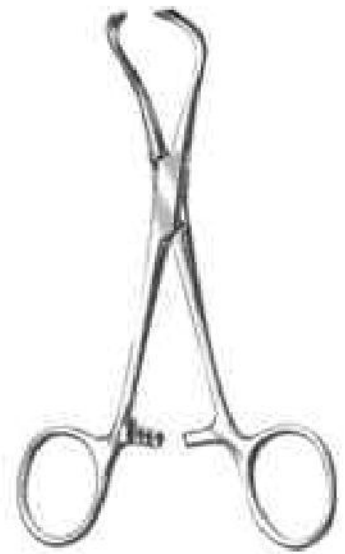

2575
LORNA
Non Perforated
3 1/2"



Retractors, Depressors, Mouth Gags



2576
DENHARDT



2577
DENHARDT
MOUTH GAG with
Silicon Inserts
Interchangeable
Size: 125mm

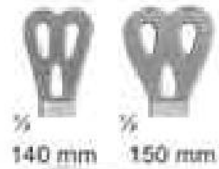

140 mm 150 mm



2578
WEIDER
Tongue depressor
2579 140mm
2580 150mm

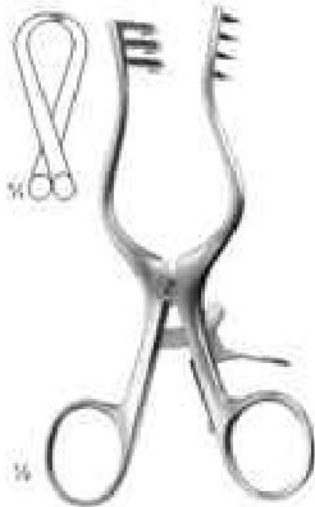

2583
WEITLANER
Sharp
130mm

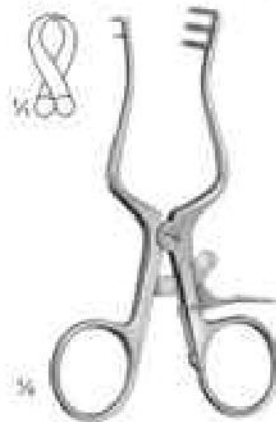

2584
WEITLANER
Sharp
110mm

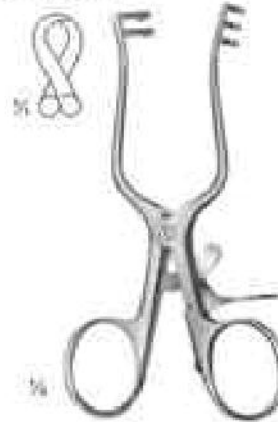

2585
WEITLANER
Semi Sharp
110mm



2581
TOBOLD
Tongue depressor
145mm



2582
ANDREW
Tongue depressor
110mm



2586
MOLT
Pediatric



2587
MOLT
Child



2588
MOLT
Adult



2589
FERGUSON ACKLAND
Mouth Gag
Size: 145mm



2590
ROSER KOENIG
Mouth Gag
Size: 160mm/ 185mm



Lip & Cheek Retractors



2591
140mm



2592
BRUENINGS
140mm



2593



2594



2595



2596



2597



2598



2602



2603



2599
Mouth Gag with
Tounge Deperessor
11.0 cm
13.0 cm
15.0 cm

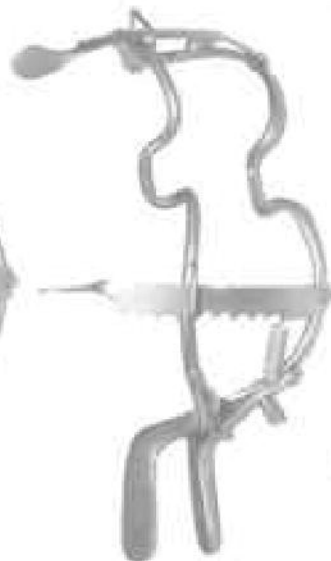

2600
Mouth Gag with
Tounge Deperessor
11.0 cm
13.0 cm
15.0 cm



2601
Jennings, Mouth Gag
11.0 cm
13.0 cm
15.0 cm



Lip & Cheek Retractors

- 30 x 4 mm A
- 23 x 7 mm B
- 24 x 11 mm C
- 29 x 10 mm D
- 30 x 11 mm E
- 32 x 14 mm F
- 40 x 11 mm G
- 42 x 10 mm H
- 50 x 11 mm I
- 55 x 11 mm J
- 60 x 11 mm K
- 70 x 11 mm L
- 70 x 14 mm M



**2604
LANGENBECK
210mm**



**2605
KOCHER LANGENBECK
215mm**



**2606
BUCHS
205mm**



38 x 18 mm



**2607
KOCHER
230mm**



**2608
MIDDELDORPF**



**2609
15x15 Teeth
220mm**

**2610
29x22mm
215mm**

**2611
28x28mm
235mm**



**2612
KOCHER
230mm**



**2613
COLLIN
150mm**



**2614
ROUX
Set
165mm**



Sterilizing Forceps

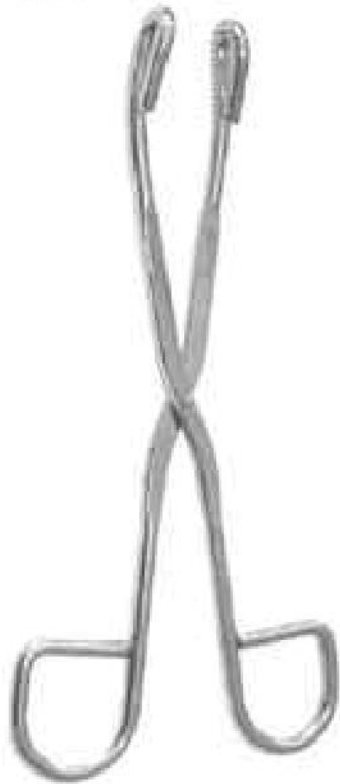

2615
Sterilizing Forcep Curved
20 cm A
25 cm B
30 cm C

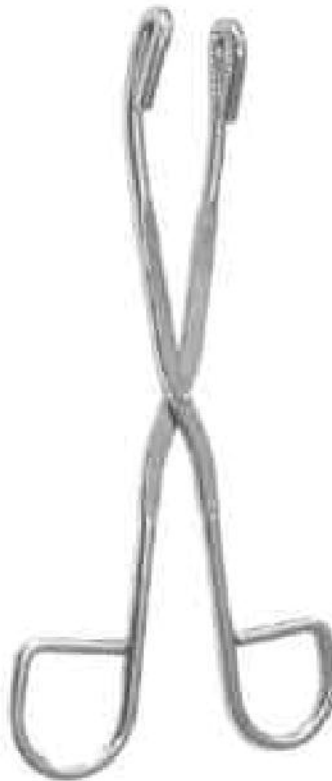

2616
Sterilizing Forcep Straight
20 cm A
25 cm B
30 cm C



2617
Sterilizing Forcep
30 cm

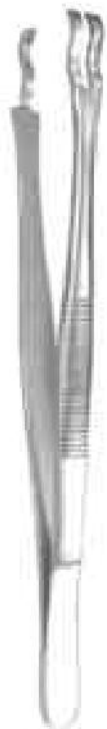

2618
Becht Tweezer



2619
Sterilizing Forcep
23 cm A
30 cm B



2620
Sterilizing Forcep
20 cm



Tissue Retractors & Hooks



2621
3 Sharp prongs



2622
2 Sharp prongs
6"



2623
2 Sharp prongs
6"



2624
FOMON
145mm



2625
ALM
70mm



2626
SENN
3 Sharp Prongs
6 3/8"



2627
TOENNIS
Dura Retractor
150mm



2628
JOSEPH
165mm



2629
GILLIES
180mm

Section - 07

- * Orthodontic Pliers
- * Orthodontic Cutters
- * Rongeurs
- * Needle Holders





Orthodontic Pliers



2630
Light Wire Cutter



2631
Wire Cutter



2632
Posterior Band Remover
Long



2633
Posterior Band Remover



2634
Jarabak Plier



2635
Distal End Cutter
Safety End Cutter



2636
Distal End Cutter



2637
Kim's Plier

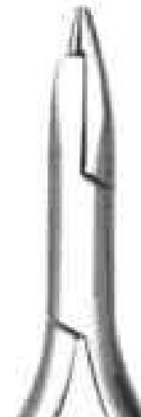

2638
Loop Forming Plier



2639
Tweed Arch Bending Plier



2640
Utility Plier



2641
Bonding Bracket Remover



2642
Lingual Arch Plier



2643
Light Wire Plier



2644
Wire Cutter
12.5cm



Orthodontic Pliers



2645
Fig. 101
Wire Bending



2646
Fig. 118
PEESO
Collar



2647
Fig. 417
Crown Shell

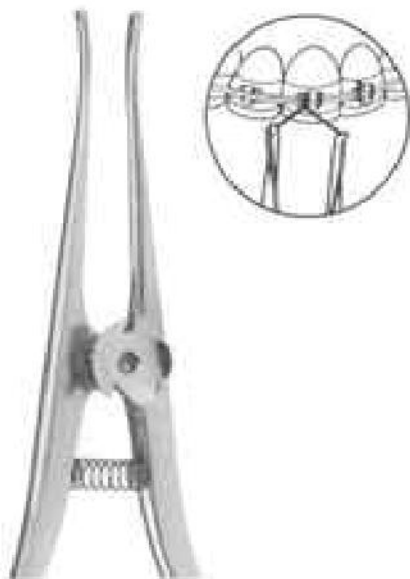

2645
STEINER
150 mm
Ligature Pliers

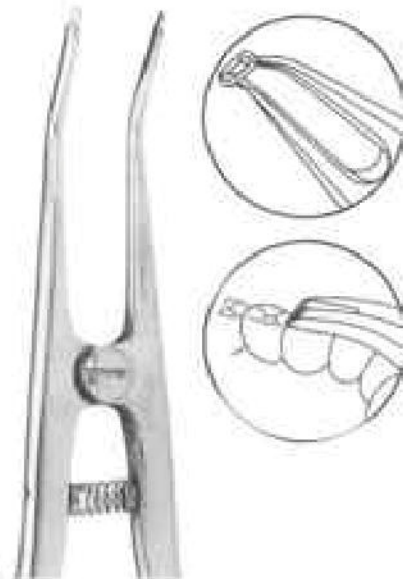

2649
Separating Pliers Elastics
150 mm



2650
121 lab & Office



Orthodontic Pliers



2651
How Plier Titanium Alloy
with special coated beaks



2652
How Plier
Tips are 3.2 mm Diameter



2653
How Plier
Tips are 3.2 mm Diameter



2654
How Plier Small
Tips are 3.2 mm Diameter



2655
How Plier Offset
Tips are 3.2 mm Diameter

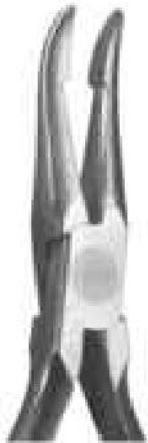

2656
Weingart Utility Plier
Titanium Alloy
with special coated beaks

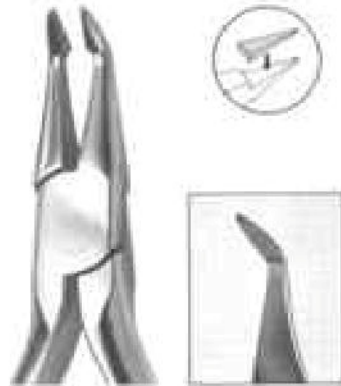

2657
Weingart Utility Plier
New type of the Weingart Utility Plier
designed for a more precise operation



2658
Weingart Utility Plier



2659
Weingart Utility Plier

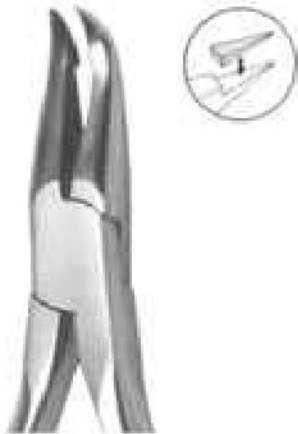

2660
Weingart Utility Plier



2661
Bird Beak Plier with Cutter
Maximum Banding &
Cutting Capacity
Wires up to .032°



2662
Bird Beak Plier with Cutter
Maximum Banding Capacity
Wires up to .032°



2663
Bird Beak Plier with Cutter
Maximum Banding Capacity
Wires up to .030°



Orthodontic Pliers



2664
TWEED (Fig. 98)
13 cm
Tweed Loop Omega Pliers

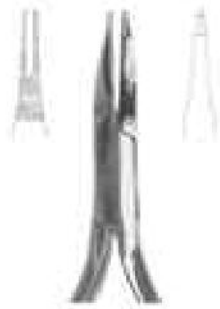

2665
TWEED (Fig. 90)
14 cm



2666
O'BRIEN (Fig. 97)
14 cm

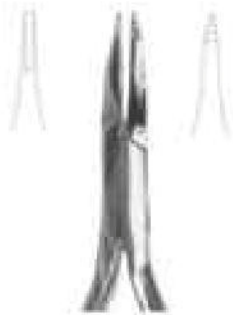

2667
TWEED (Fig. 96)
14 cm

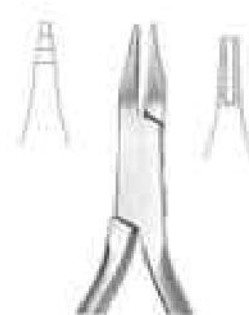

2668
TWEED (Fig. 95)
13.5 cm

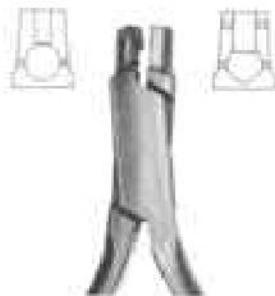

2669
SCHWARZ (Fig. 29)
12.5 cm

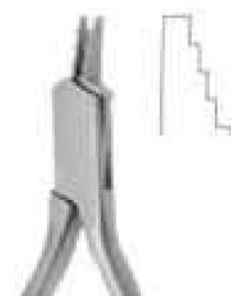

2670
NANCE (Fig. 80)
13 cm

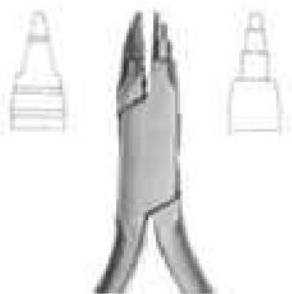

2671
YOUNG (Fig. 58)
13 cm



2672
SCHWARZ (Fig. 30)
13 cm

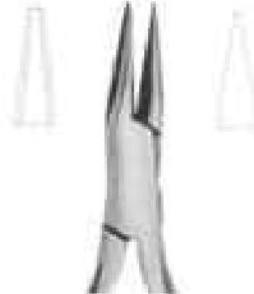

2673
Optical Plier (Fig. 53)
14 cm

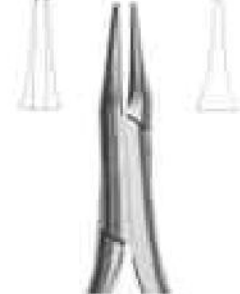

2674
Schwarz (Fig. 79)
13.5 cm



Orthodontic Pliers



2675
NANCE (Fig. 56)
12.5 cm
wire bending pliers



2676
JOHNSON (Fig. 59)
13.5 cm
Contouring plier

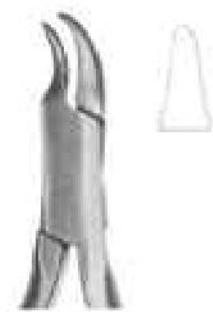

2677
REYNOLDS (Fig. 61)
13 cm
Contouring plier

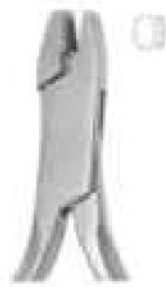

2678
De La Rosa (Fig. 34)
12.5 cm
Contouring plier, Non Grooved



2679
De La Rosa (Fig. 35)
12.5 cm
Contouring plier, Grooved



2680
14 cm
Goslee Contouring Plier

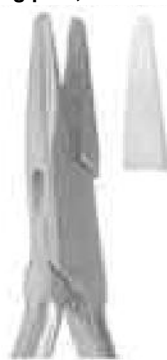

2681
14 cm
Goslee Contouring Plier



2682



2683
Fig. 58
12.5 cm
Lingual Arch bending Plier



2684
12.5 cm
Frevert Tweed (Fig. 51)
Tweed Arch Plier/ Standard Jaw

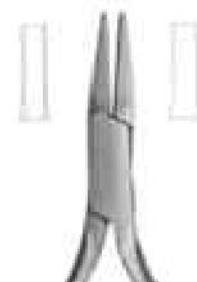

2685



2685
13 cm
ANGLE (Fig. 52)
Arch Forming Plier



Orthodontic Pliers



2687
Fig. 60
13 cm
Wire & Clasp Bending Pliers



2688
Fig. 60
13 cm
Wire & Clasp Bending Pliers

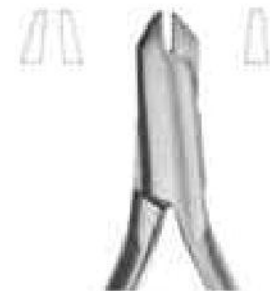

2689
Aderer (Fig. 57)
12 cm
Wire & Clasp Bending Pliers



2690
49 e 49 TC
14 cm
Band Removing Pliers Short Pad



2691
50 e 50 TC
14 cm
Band Removing Pliers Long Pad

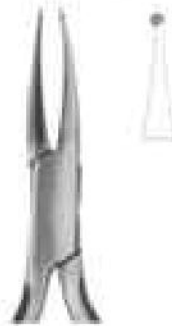

2692
Fig. 84
14.5 cm
Band Pinshing & Ligature locking plier, serrated



2693
Fig. 72
14 cm
Band Pinshing & Ligature locking plier, serrated



2694
BRACKET (Fig. 82)
13.5 cm
Direct Bonding Bracket Remover



2695
BRACKET (Fig. 83)
13.5 cm
Direct Bonding Bracket Remover



Orthodontic Pliers

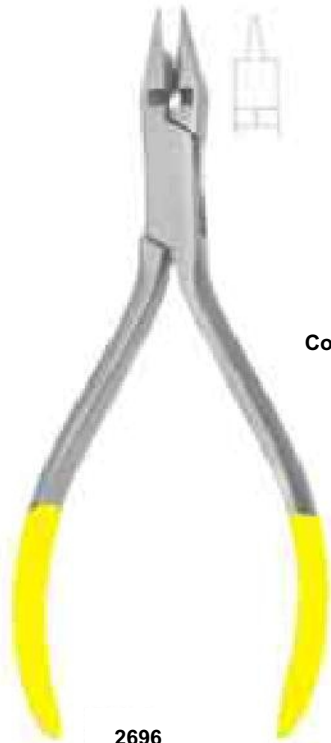

2696
38C, 38TC
13.5 cm
Contouring closing loop pliers
wire bending cutter

2697
40C, 40TC
13.5 cm
Contouring Pliers light wire pliers
grooved with cutter

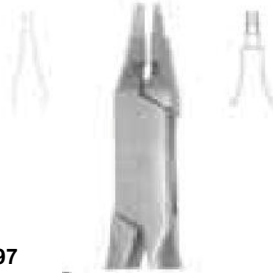

2698
Fig. 81
12.5 cm
Sling clasp & wire bending plier



2699
Fig. 28
14 cm
Sling clasp & wire bending plier



2700
Fig. 21
13 cm
Light wire bending pliers, grooved



2704
46C, 46TC
ADAMS -N 139c
12.5 cm
Bird beak with cutter



2701
ADAMS 23, 23TC
12.5 cm
Sling clasp & wire bending plier



2702
ADAMS (Fig. 33)
12.5 cm
For Retaining elements



2703
ADAMS (Fig. 44)
12.5 cm
Sling clasp & wire bending plier



2705
Universal Wire Bending
Pliers (ADAMS) 47 TC, N 64
12.5 cm
Sling clasp & wire bending plier.



2706
86 C 86 TC
Angle Bird Beak - N 64
12.5 cm
Sling clasp & wire bending plier.



Orthodontic Cutters with T.C



Ø 1.0 mm
(0.40")

2707
Fig. 18 TC
15 cm



Ø 1.0 mm
(0.40")

2708
Fig. 92 TC
14 cm



Ø 0.4 mm
(0.16")

2709
Fig. 91 TC
13 cm



Ø 0.4 mm
(0.16")

2710
Fig. 99 TC
13 cm



Ø 0.4 mm
(0.16")

2711
Fig. 94 TC
13 cm
Angled at 15D with or
without spring on
the handles



2712
Fig. 85 TC
13 cm

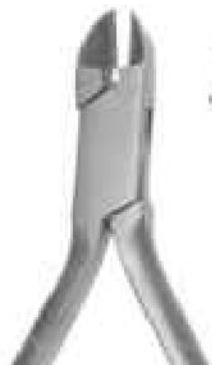

2713
Fig. 87 TC
13 cm



2714
Fig. 85 TC
Angled at 15D
13 cm



2715
ADAMS 87 TC
Angled at 15D
13 cm



Orthodontic Distal & Cutters



2716
Fig. 89 TC



2717
Fig. 64 TC
13 cm



2718
Fig. 67 TC
13 cm



2719
Fig. 88 TC
13 cm



2720
Fig. 77 TC
13 cm



Pliers For Orthodontic & Prosthetics



**2721
UNIVERSAL
150 mm**

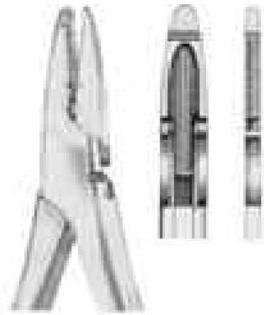

**2722
WALDSACHS
155 mm**



**2723
ADERER
125 mm**



**2724
NANCE
125 mm**

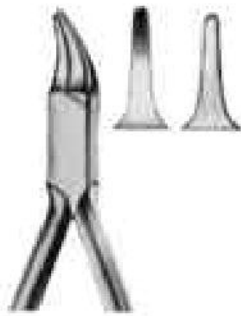

**2725
REYNOLDS
125 mm**



**2726
HOW
145 mm**



**2727
HOW
140 mm**



**2731
FURRER
150 mm**

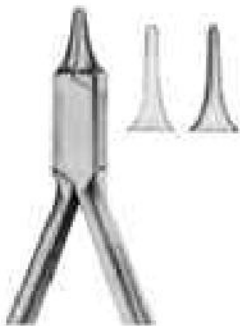

**2728
WALDRON
125 mm**



**2729
ADAMS
125 mm**

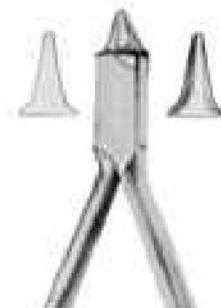

**2730
ANGLE
125 mm**

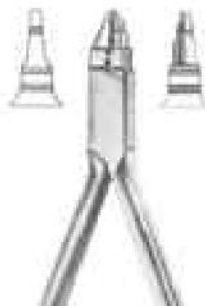

**2732
YOUNG
130 mm**



**2733
NANCE
130 mm**



Pliers For Orthodontic & Prosthetics



**2734
LANGEBECH
125 mm**



**2735
LANGEBECH
140 mm**



**2736
LANGEBECH
130 mm**



**2737
PEESO
125 mm**



**2738
GOSLEE
125 mm**

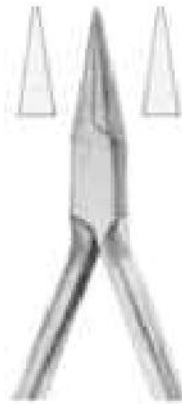

**2739
FISCHER
140 mm**



**2740
FISCHER
140 mm**

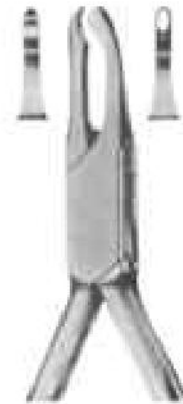

**2741
JOHNSON
130 mm**

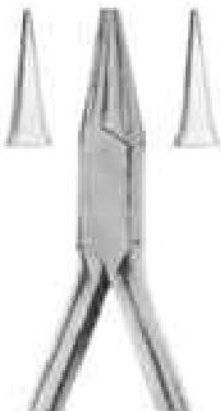

**2742
MSY
130 mm**



**2743
MC KELLOPS
155 mm**



**2744
ANDRESEN
130 mm**

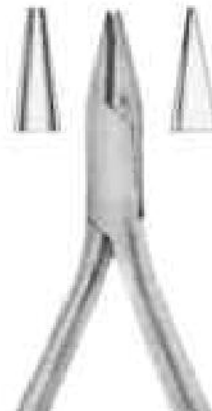

**2745
SCHWARZ
130 mm**



Rongeurs



2746
BLUMENTHAL
6", 30D Standard



2747
MINI-BLUMENTHAL
6", 45D



2748
MINI-BLUMENTHAL
6", 90D

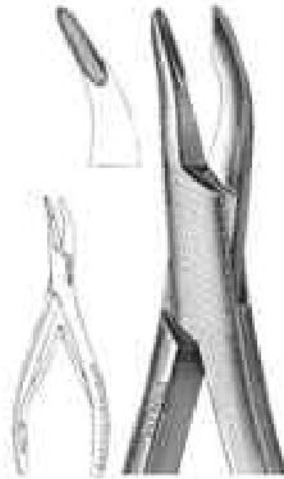

2749
BLUMENTHAL
7", 30D



2750
MINI-BLUMENTHAL
4 1/2", 30D



2751
MINI-BLUMENTHAL
4 1/2", 45D



Rongeurs



2752
CLEVELAND
No. 5-Side Cutting
6 3/4"



2753
CLEVELAND
No. 5A-Side Cutting
6 1/2"

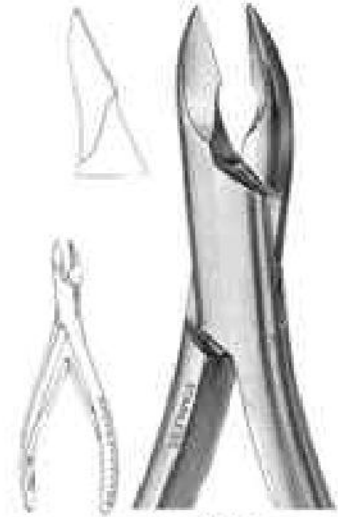

2754
CLEVELAND
No. 55 Side Cutting
6"

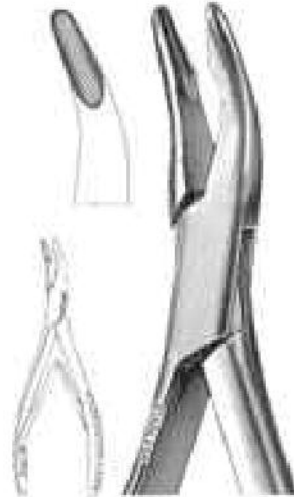

2755
NO. 1A-MEAD
6 1/2"

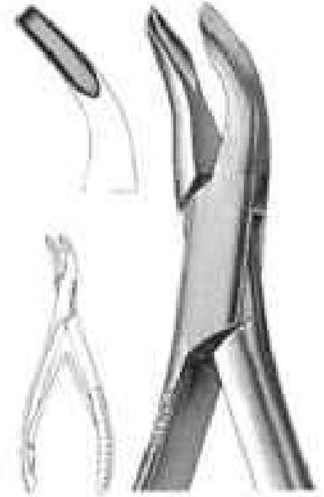

2756
MEAD Square
No. 2A
6 1/2"



2757



Rongeurs



2757
FRIEDMAN
5 1/2"



2758
MICRO-FRIEDMAN
5 1/2" 15D Curved Jaws

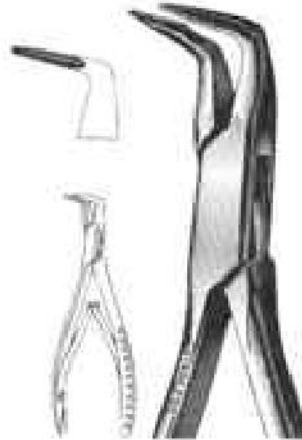

2759
MICRO-FRIEDMAN
Perio Rongeur 5 1/2"



2760
CLEVELAND
No. 4 5 1/2"



2761
CLEVELAND
No. 4A 6 1/2"

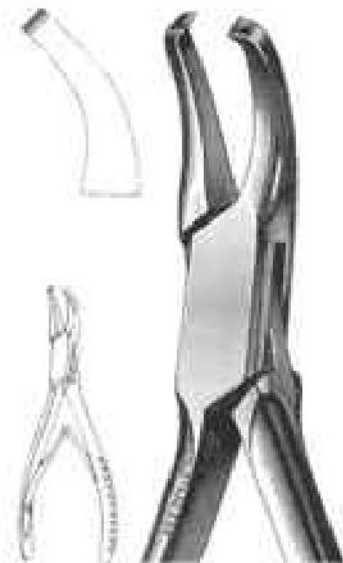

2762
GARDNER
No. 6A, End Cutting
6 1/2"



Rongeurs



2763
BEYER
DOUBLE ACTION
16, 18 cm



2764
No.1
6 1/2"

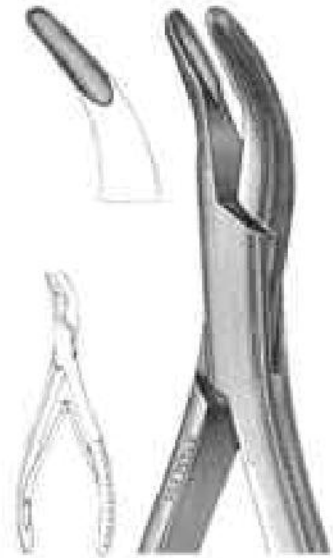

2765
HARTMAN
5 3/4"
Strong Curve



2766
BANE
Slight Curve
7"



Needle Holders



2767
COLLIER
5" Fenestrated Jaws



2768
DERF
4 3/4"

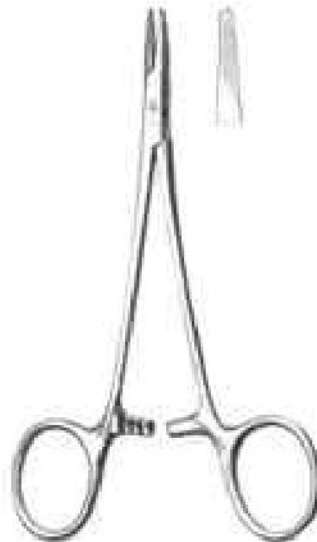

2769
WEBSTER
Delicate Smooth Jaws
5"



2770
NEIVERT
One Offset Ring
5"



2771
OLSEN-HEGAR
5 1/2"



2772
BAUMGARTNER
5 1/2"



2773
CRILE-WOOD
6"



2774
GARDNER
5"



Needle Holders



2775
MAYO-HEGAR
5"



2776
CASTTROVIEJO
Smooth Jaws
14 cm"

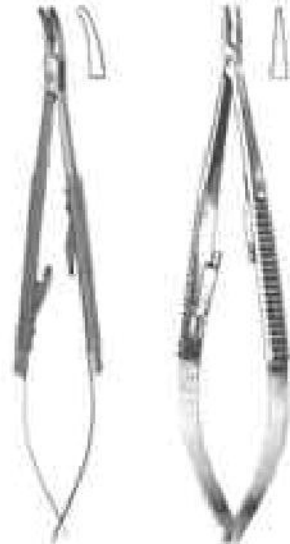

2777
CASTTROVIEJO
Smooth Jaws
14 cm"



2778
CASTTROVIEJO
Smooth Jaws
14 cm"

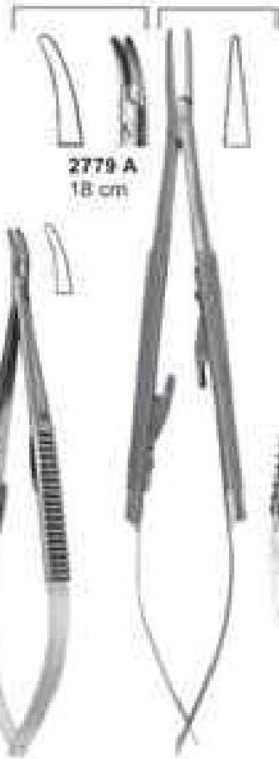

2778A
CASTTROVIEJO
Smooth Jaws
14 cm"

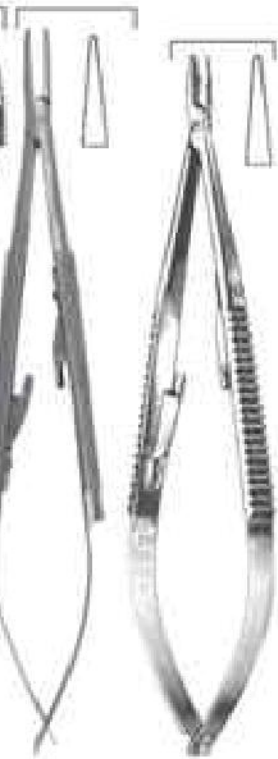

2779
CASTTROVIEJO
Smooth Jaws
18 cm"



2780
CASTTROVIEJO
Smooth Jaws
18 cm"



2781
BOYNTON
5"



2782
CRILE
6"



2783
MATHIEU
5 1/2"



2784
STEVENS
6 1/2"



Micro Surgery Set



2785
Micro Scissor
Straight 155mm



2786
Micro Scissor
Straight 150mm



2787
Micro Scissor
Curved 150mm



2788
Micro Scissor
Curved 155mm



2789
CASTROVIEJO
T.C
Straight 180mm



2790
Retractor
Fig. 3
165 mm



2791
Micro Adson
120 mm



2792
GERALD
Curved
180 mm



2793
GERALD
Straight
175 mm



2794
Micro Adson
160 mm



2795
Micro Surgery Set 10 pcs

Section - 08

- * Scissors
- * Impression Trays
- * Articulators
- * Hollow Wares
- * T.C. Instruments





Scissors



2796
IRIS (Standard)
Straight
11.5 cm



2797
IRIS (Standard)
Curved
11.5 cm

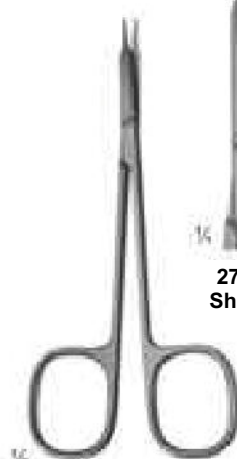

2798
STEVENS
Dissecting Scissors
Size: 11.5 cm

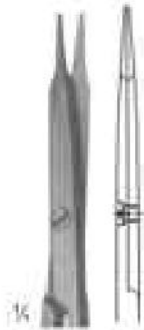

2799
Sharp



2800
Sharp



2801
Blunt

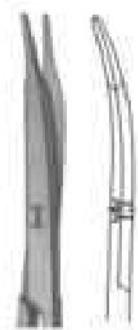

2802
Blunt



2803



2804
JOSEPH
Size: 150 mm

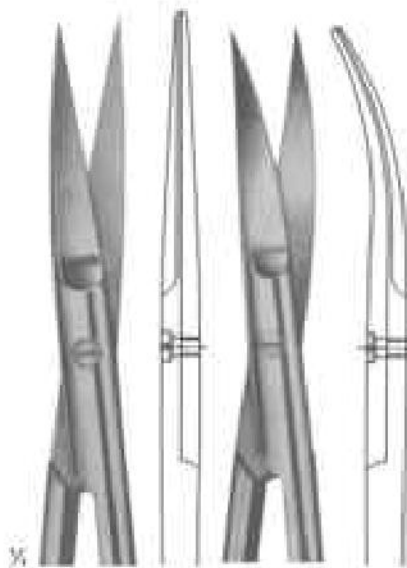

2805

2806

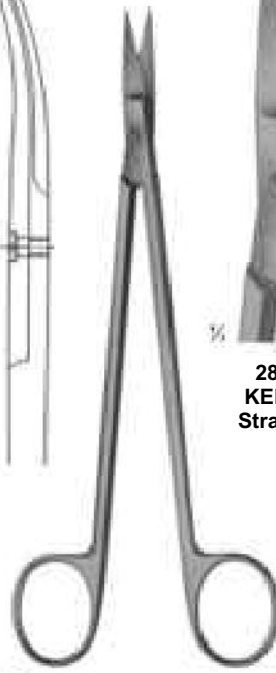

2807
KELLY
Size: 175 mm

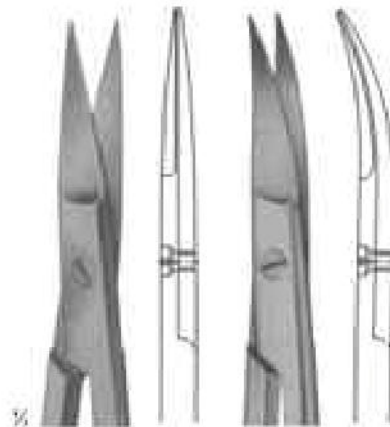

2808
KELLY
Straight

2809
KELLY
Curved

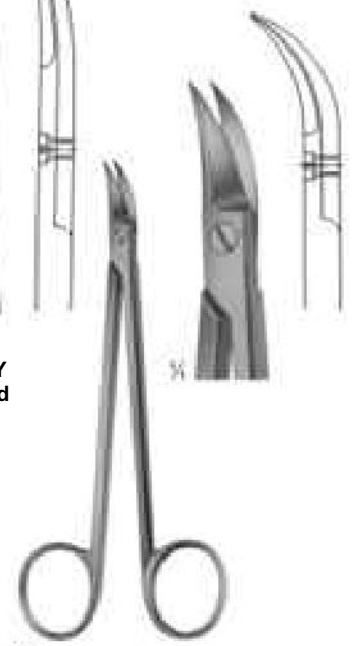

2810
QUINBY
Size: 130mm



Scissors



2811
Standard -Types
Size: 115 mm



2812
DEAVER
with flat lock



2813
Size: 145 mm



2814
Size: 145 mm



2815
Size: 145 mm



2816
LITTLER
DISSECTING SCISSORS
Size: 115 mm



2817
COTTLE
Building scissors
Size: 115 mm

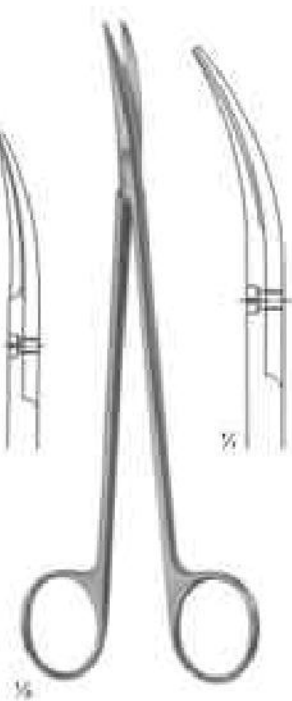

2818
DE-BAKEY
Ateryotomy scissors
Size: 175 mm

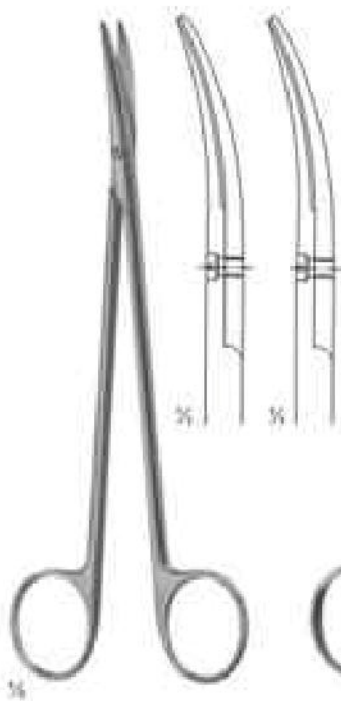

2819
TOENNIS - ADSON
Dissecting scissors
Size: 175 mm

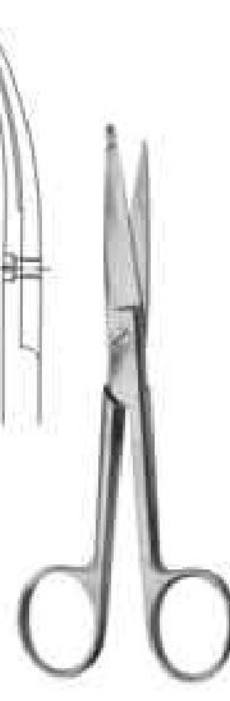

2820
KNOWLES
Size: 145 mm



2821
Lister



Scissors

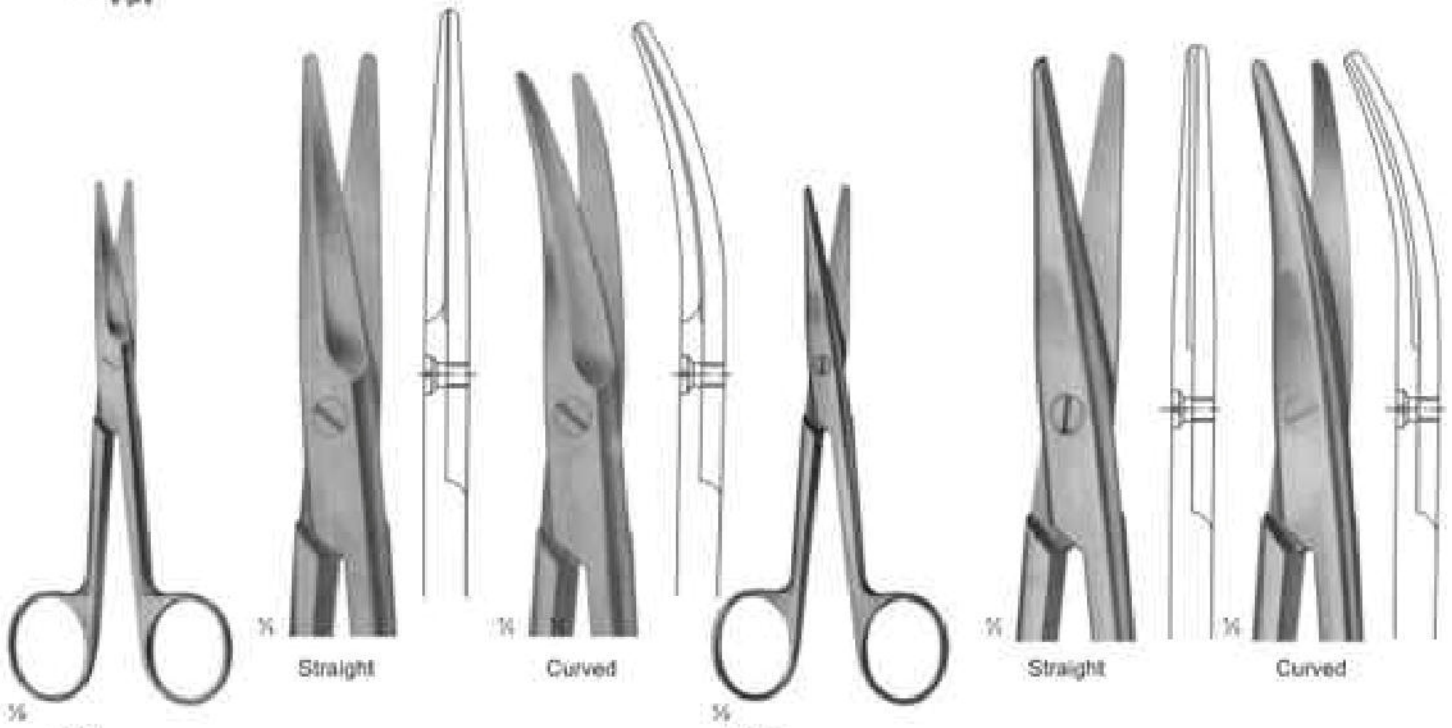

2822
MAYO (straight)
Size: 140 mm

2823
MAYO-STILLE (straight)
Size: 140 mm

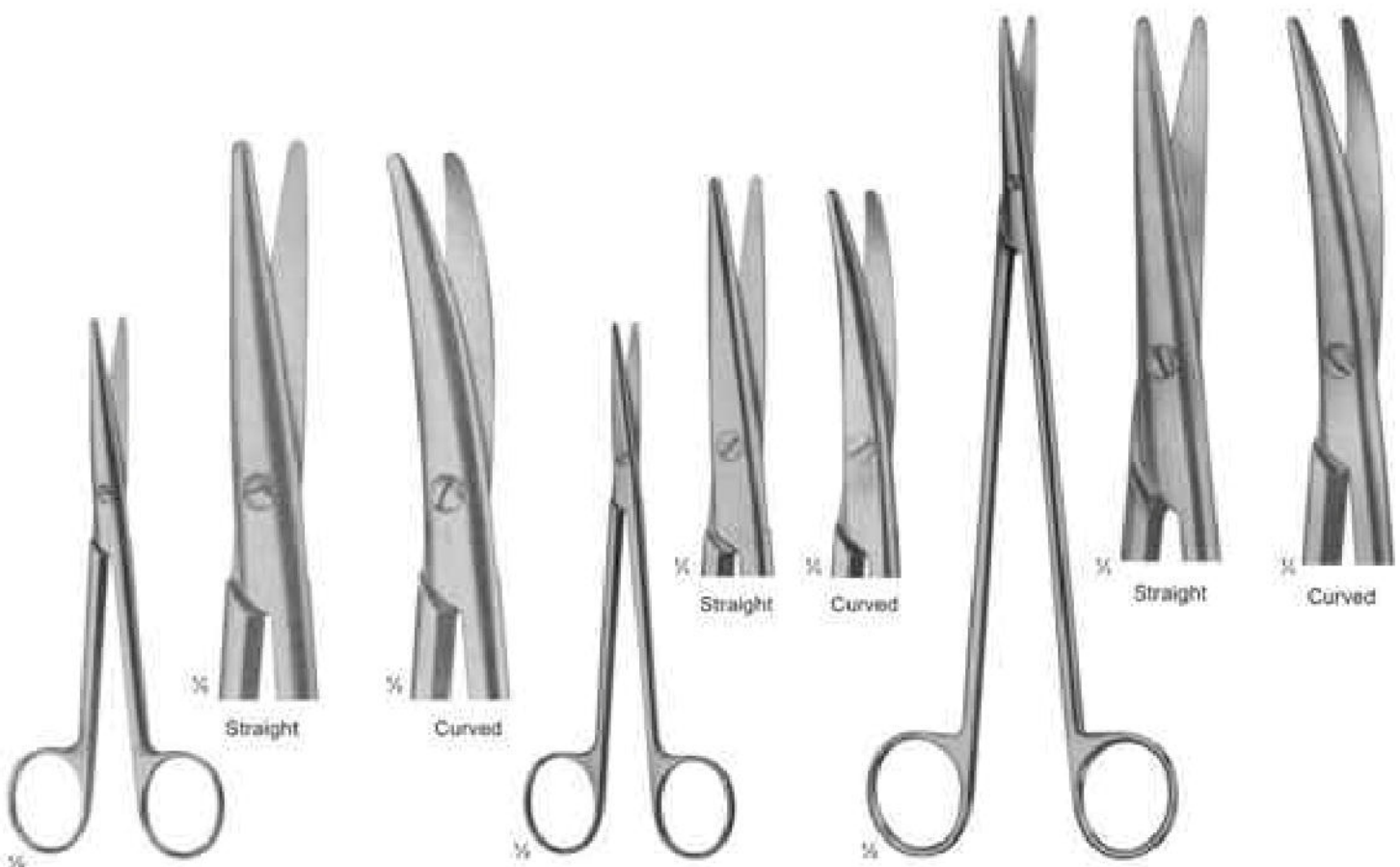

2824
STILLE
Size: 140 mm

2825
METZENBAUM
Size: 145 mm

2826
NELSON-METZENBAUM
Size: 230mm



Scissors



2827
DE BAKEY
Size: 155mm

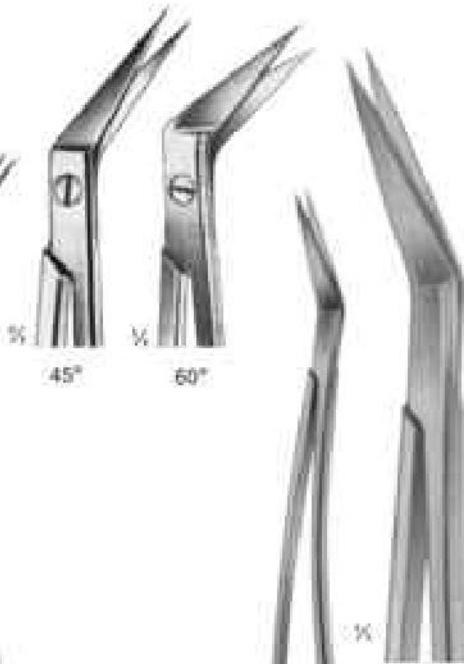

2828
LOCKLIN
Curved sideways
1 Toothed Blade
Size: 155 mm



2829
LaGrange
Double Curved
11.5 cm



2830
Goldman-Fox
Double Curved
13 cm



2831
SPENCER
Size: 90 mm

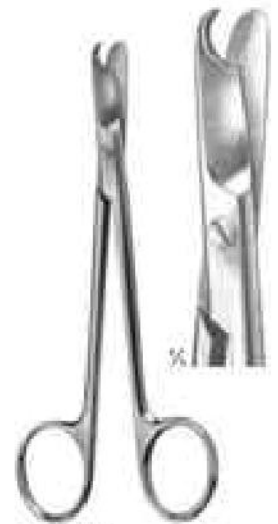

2832
LITTAUER
Size: 135 mm



2833
DEEBEE
Size: 110mm

2834

2835

2836

2837

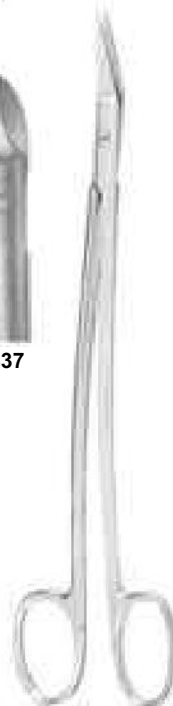

2838
Dean
17cm



2839
1 Blade Serrated
Size: 120mm

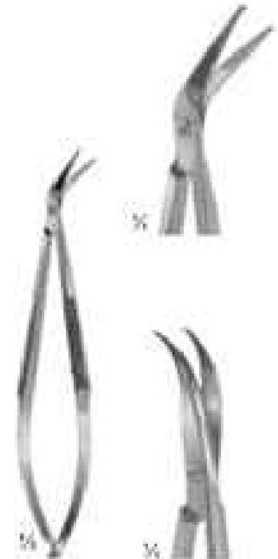

2840
CASTROVIEJO
Size: 90mm



Impression Trays

Made of 18/8 Stainless Steel, Solid, Set of 10

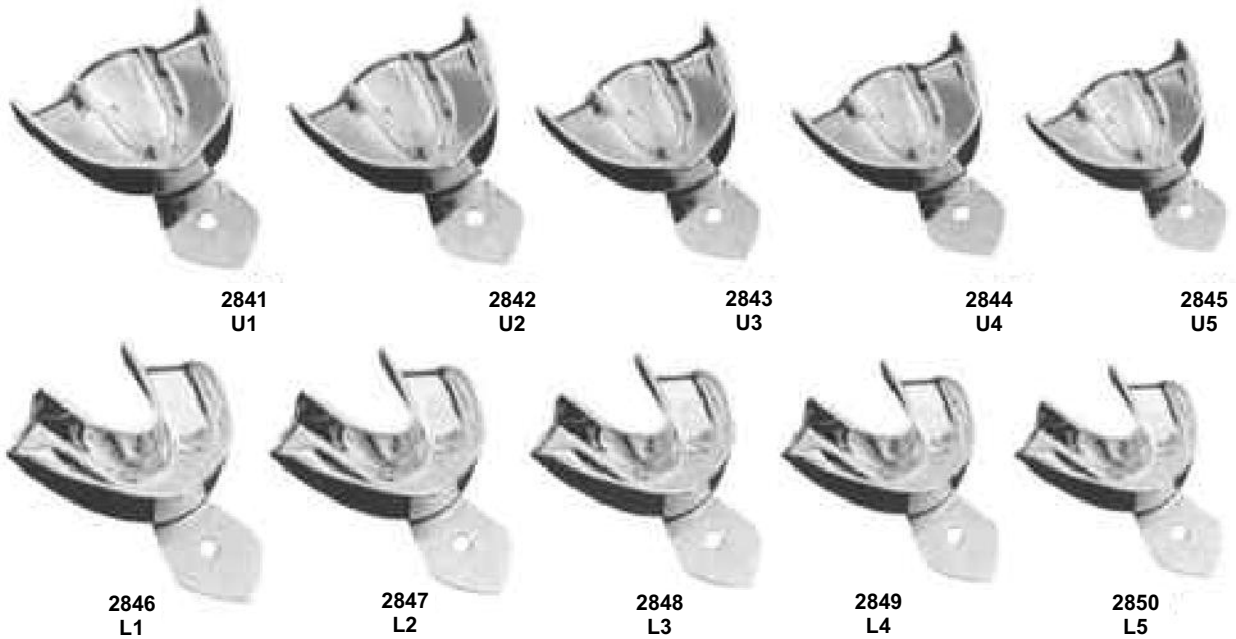

All The Above Impression Trays are Available in These 5 Sizes

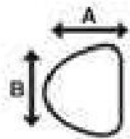

UPPER	U1	U2	U3	U4	U5
	A	62	60	53	54
B	83	75	73	69	68

All Dimension are in mm

LOWER	L1	L2	L3	L4	L5
	A	63	61	57	60
B	82	81	78	74	71

All Dimension are in mm



Perforated, Set of 10

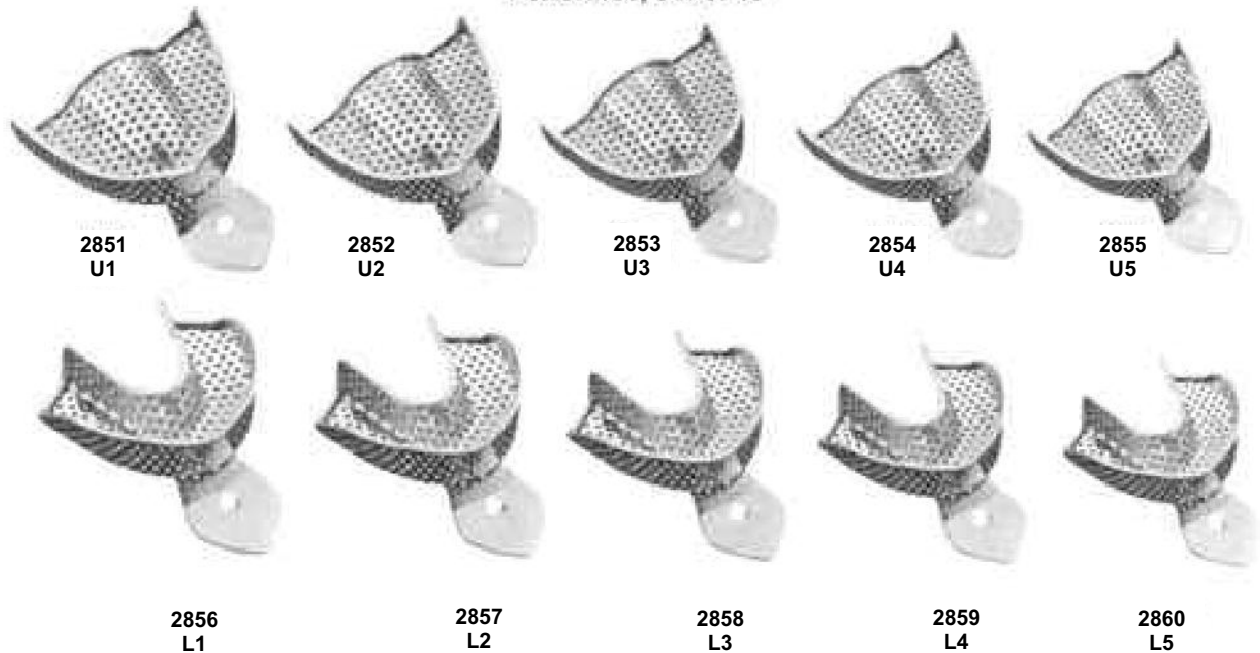



Impression Trays

Made of 18/8 Stainless Steel, Solid Full Denture Set of 8

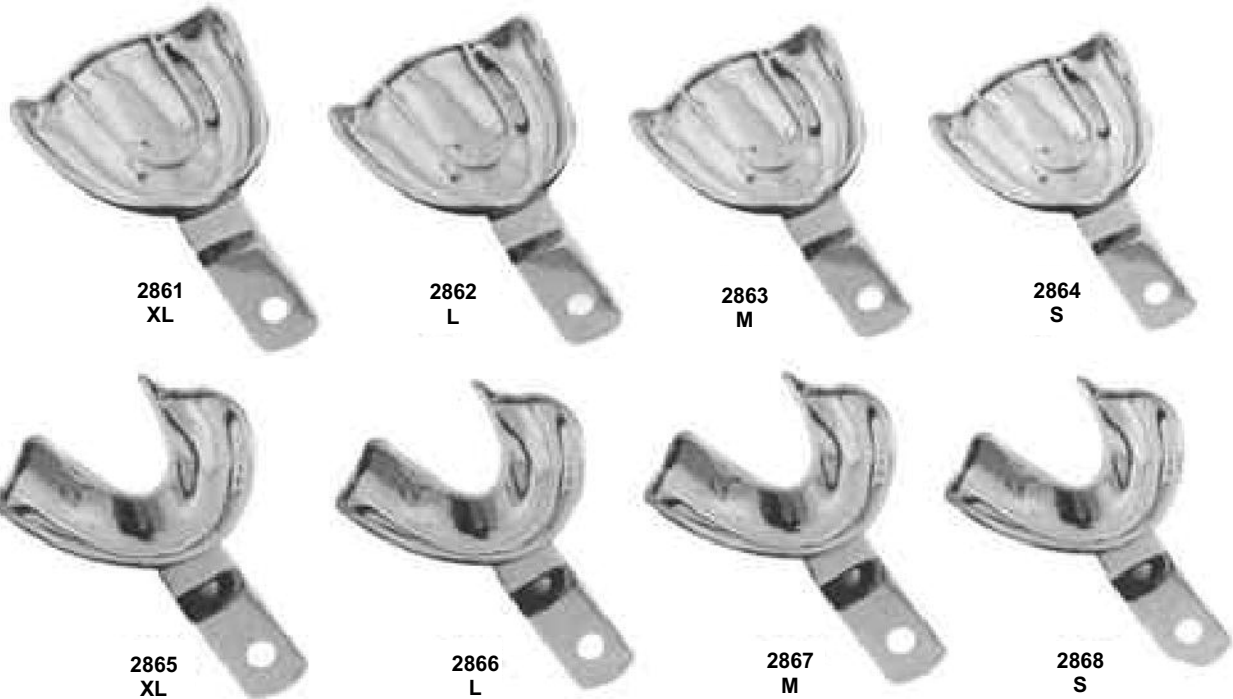

All The Above Impression Trays are Available in These 4 Sizes

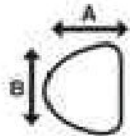

UPPER		XL	L	M	S
	A	70	67	64	60
B	79	76	70	73	

All Dimension are in mm

LOWER		XL	L	M	S
	A	64	64	60	57
B	86	70	73	70	

All Dimension are in mm

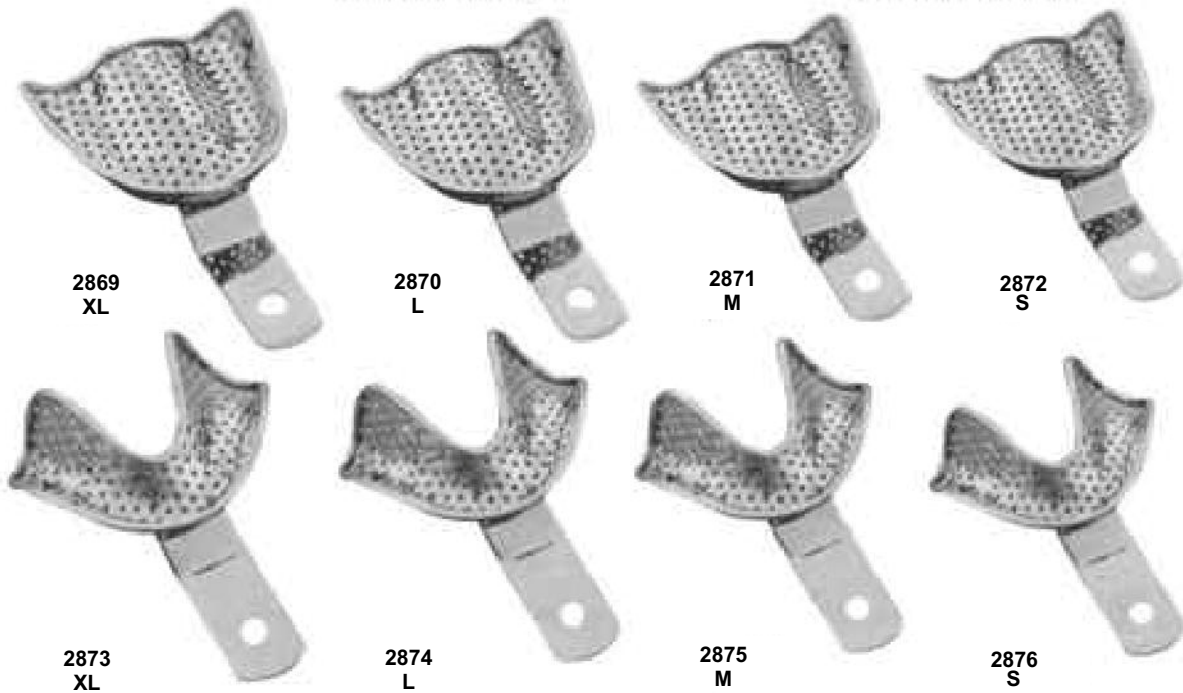

Perforated Full Denture Set of 8



Impression Trays

Made of 18/8 Stainless Steel, Solid Set of 6



2877
U1



2878
U2



2879
U3



2880
L1



2881
L2



2882
L3

All The Above Impression Trays are Available in These 4 Sizes

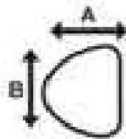

UPPER		U1	U2	U3
	A	67	64	57
B	81	71	70	

All Dimension are in mm

LOWER		L1	L2	L3
	A	60	57	54
B	81	79	76	

All Dimension are in mm



2883
U1



2884
U2



2885
U3



2886
L1



2887
L2



2888
L3

Perforated Set of 6



Impression Trays

Made of 18/8 Stainless Steel, English Pattern Set of 8



2889
LOWER



2890
UPPER

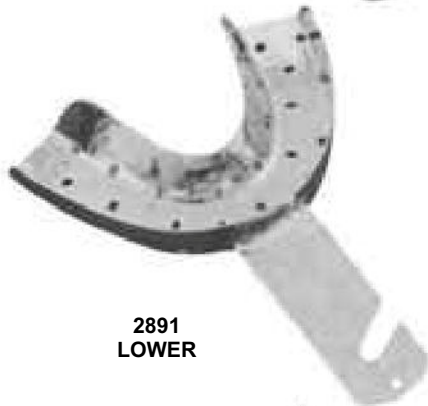

2891
LOWER



2892
UPPER



2893
LOWER



2894
UPPER

All The Above Impression Trays are Available in These 4 Sizes

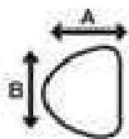

UPPER	Size	A	B	C
	0	67	50	12
	1	72	51	13
	2	78	55	15
	3	80	58	15

All Dimension are in mm

LOWER	Size	A	B	C
	0	70	50	14
	1	77	51	15
	2	79	55	15
	3	80	60	17

All Dimension are in mm





Impression Trays

Made of 18/8 Stainless Steel, Solid Full Denture Set of 8

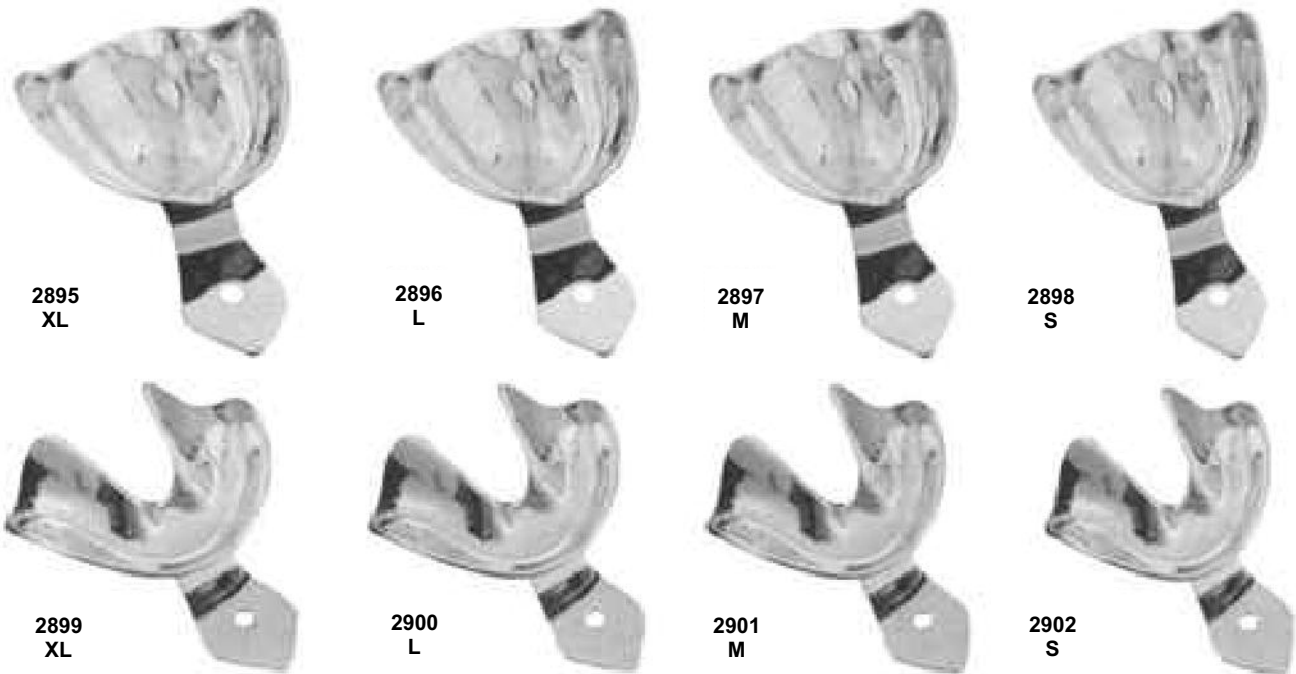

2895
XL

2896
L

2897
M

2898
S

2899
XL

2900
L

2901
M

2902
S

All The Above Impression Trays are Available in These 4 Sizes

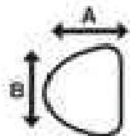

UPPER		XL	L	M	S
	A	70	67	64	60
B	79	76	70	73	

All Dimension are in mm

LOWER		XL	L	M	S
	A	64	64	60	57
B	86	70	73	70	

All Dimension are in mm

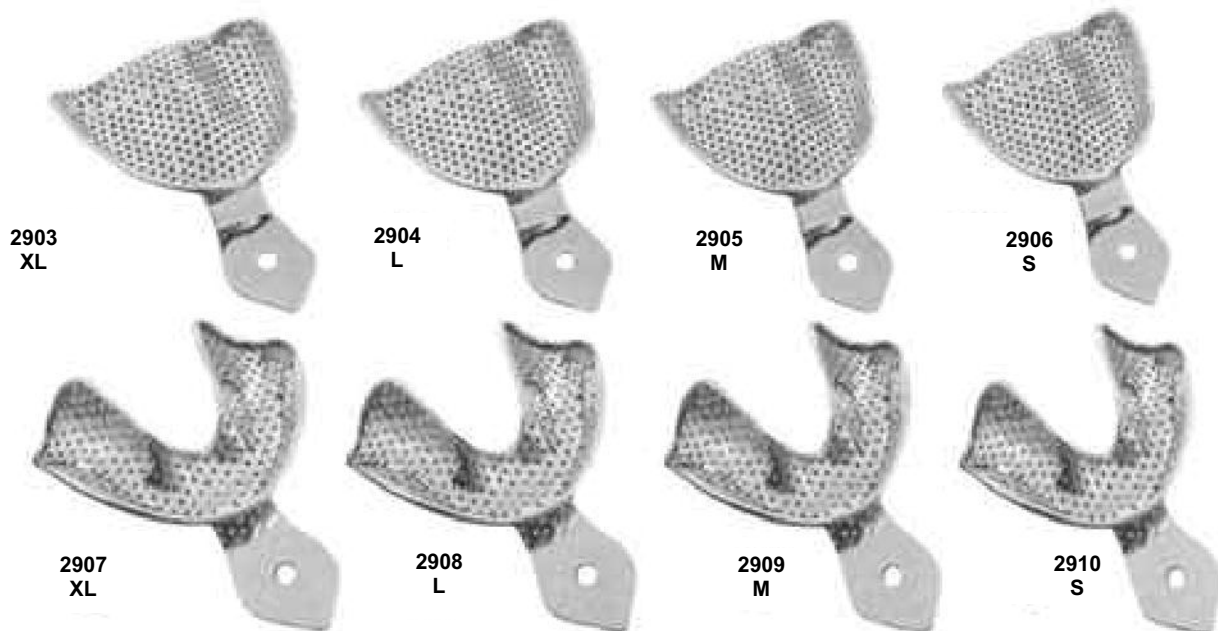

2903
XL

2904
L

2905
M

2906
S

2907
XL

2908
L

2909
M

2910
S

Made of 18/8 Stainless Steel, Perforated Full Denture Set of 8



Impression Trays

Made of 18/8 Stainless Steel, Solid Full Denture Set of 8



2911
U0



2912
U1



2913
U2



2914
U3



2915
L0



2916
L1



2917
L2



2918
L3

Upper Sizes: 0,1,2,3

Depth of Tray: 15,9 mm, Height of Plate: 12,5 mm

Lower Sizes: 0,1,2,3

Depth of Tray: 12,9 mm

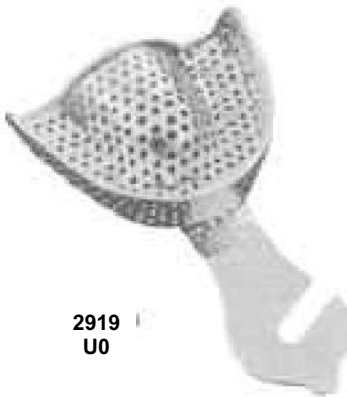

2919
U0

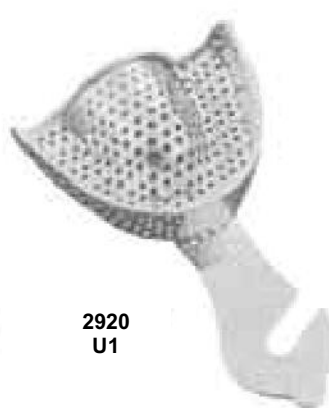

2920
U1

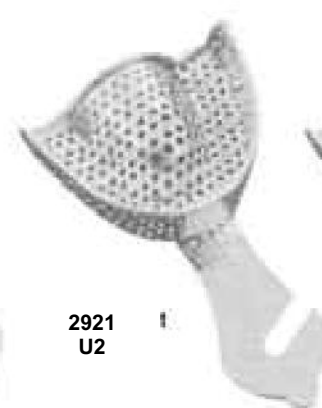

2921
U2

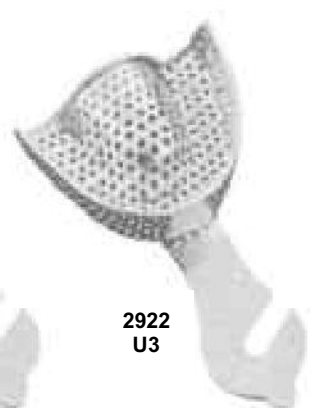

2922
U3



2923
L0

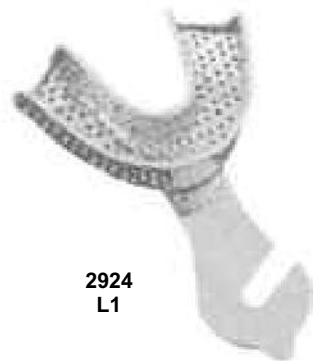

2924
L1

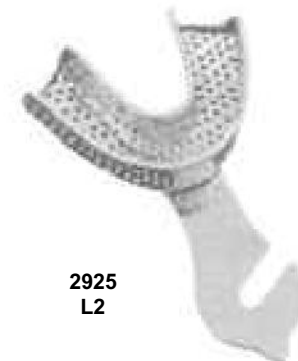

2925
L2

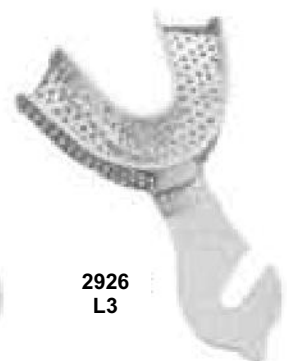

2926
L3

Made of 18/8 Stainless Steel, Perforated Full Denture Set of 8



Impression Trays

Impression Trays For Crown & Bridge Work



2927
U1P



2928
L1P

SOLID



2929
U1P

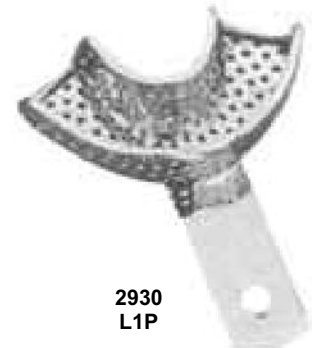

2930
L1P

PERFORATED

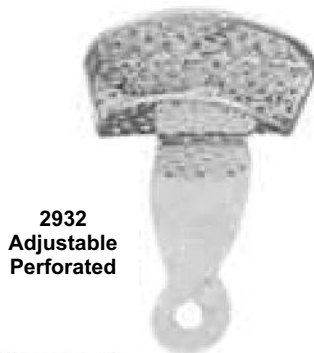

2932
Adjustable
Perforated



2933
Adjustable
Solid

PERFORATED



2931-A
For upper right jaw
For lower left jaw

2931-B
For upper left jaw
For lower right jaw

Available in 4 sizes

1.....	44 mm
2.....	55 mm
3.....	60 mm
4.....	65 mm

SOLID



2931-C
For upper right jaw
For lower left jaw

2931-D
For upper left jaw
For lower right jaw

Available in 4 sizes

1.....	44 mm
2.....	55 mm
3.....	60 mm
4.....	65 mm



Articulators



2934

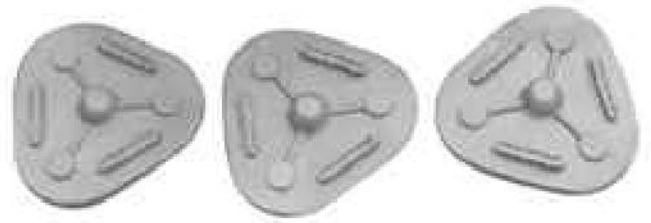

2935



2936



2937



2939



2938



Articulators



2940



2941



2942



2943



2944



2945



2946



2947



Hollowares



2948
Instrument Tray of 20 Pcs

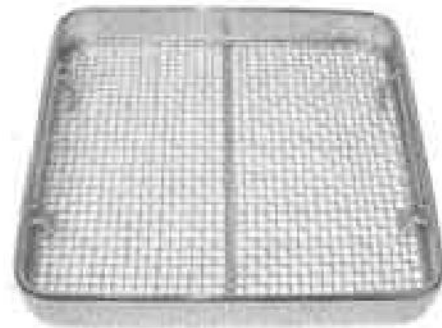

2951
Instruments Riddle



2949
Instrument Tray of 7 Pcs



2949-A
Instrument Tray of 10 Pcs



2950
Instrument Tray of 5 Pcs

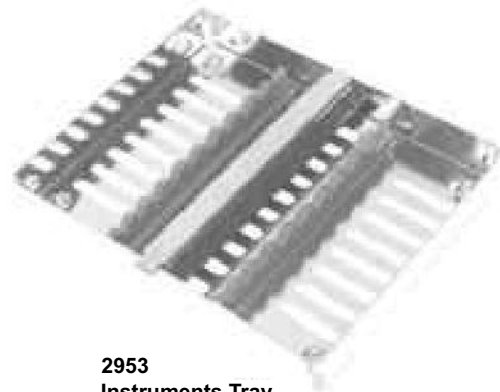

2953
Instruments Tray

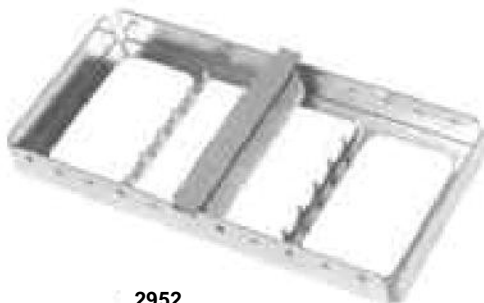

2952
Instrument Tray of 5 Pcs



2954
Instruments Tray
Perforated



2955
Instruments Tray
Perforated Base



2956
Instruments Tray
Solid Base



Hollowares



2957
Pulpectomy Tray



2958
Sterilizing Box
Available Sizes
17x17x3 cm
20x10x6 cm
30x14x8 cm



2959
Endo Tray Box



2960
Finger Cup



2961
Bur Box

2962
Sterilizing Drum
150x150mm
175x175mm
190x190mm
200x140mm
200x200mm
240x225mm
225x225mm
240x240mm
290x160mm



2963
Sterilizing Drum
280x240mm
230x150mm
300x250mm
340x160mm
250x250mm
390x200mm
280x300mm
100x100mm
150x120mm



Sterilizing Boxes & Instrument Trays



2964
Instruments Box



2965
Instruments Box



2966
Instruments Box



2967
Instruments Sterilizer
150x75 mm



2968
Endodontic Box



2969
Sterilizing Box
320x120mm



2970
Instruments Tray



2971
Instruments Tray



2972
Instruments Tray
(Perforated)



2973
Instruments Tray
Shallow(Mayo)



2974
Scaler Tray
20x10x1.5 cm



2975
Scaler Tray



2976
Scaler Tray



Hollowares



2977

2978

2979

2980

Forcep and Thermometer Jars



2981
Cotton Holding Jar
60x50 mm



2982
Spitten Mug



2983
Spirt Burner With Wick
Stainless Steel 18/10
Capacity 150ml, 80ml



2984
Spirt Burners With Wick
Stainless Steel 18/10
Capacity 70ml



2985
Dressing Jar



2986
Dressing Jar



2987
Irrigator(Douch Can)



2988
Mesuring Jug



Hollowares



2989
Sponge Bowl



2990
Wash Basin
300mm-350mm-400mm



2994
Kick Bucket With Trolley



2991
Sponge Bowl



2992
Gallipot



2993
Medicine Cup



2995
Kidney Tray Shallow
150mm-200mm-250mm-300mm



2997
Kidney Tray Without Lid
150mm-200mm-250mm-300mm



2997
Kidney Tray With Lid
150mm-200mm-250mm-300mm

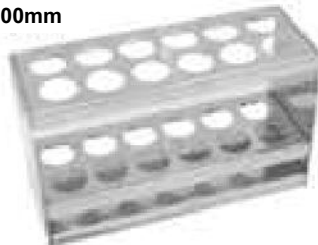

2998
Tube Rack Stainless Steel 18/10



2999
Needle Case Rectangle
Needle Case Round With Cover
90x15



3000
Dustbin Without Stand
6-10-12 ltr

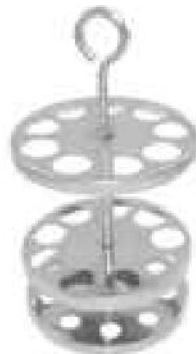

3001
Tube Rack Round Model
Stainless Steel 18/10



3002
Dustbin Without Stand & Cup
6-10-12 ltr

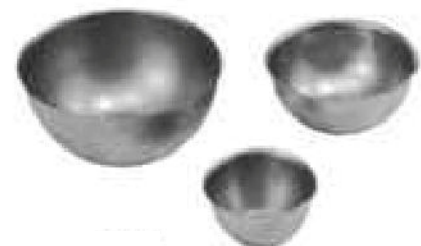

3003
Lotion Bowl With Lip
40-60-80-100-120-150-180-200mm



Scissors with Tungsten Carbide Inserts



3004
Standard

14.5cm
16.5cm
18.5cm

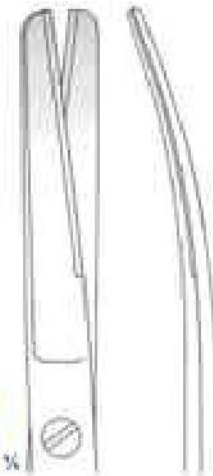

3005
Standard

14.5cm
16.5cm
18.5cm



3006
Standard

14.5cm
16.5cm
18.5cm



3007
Standard

14.5cm
16.5cm
18.5cm



3008
Standard

14.5cm
16.5cm
18.5cm



3009
Standard

14.5cm
16.5cm
18.5cm



Scissors with Tungsten Carbide Inserts



3010
MAYO-LEXER
Straight
16cm

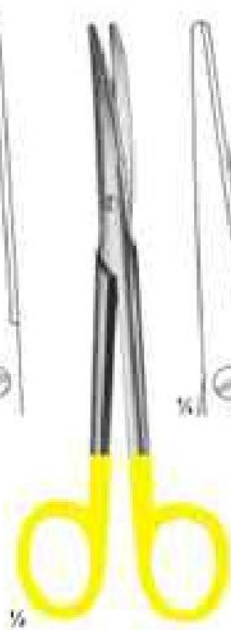

3011
MAYO-LEXER
Curved
16cm



3012
LEXER
Straight
16, 21 cm

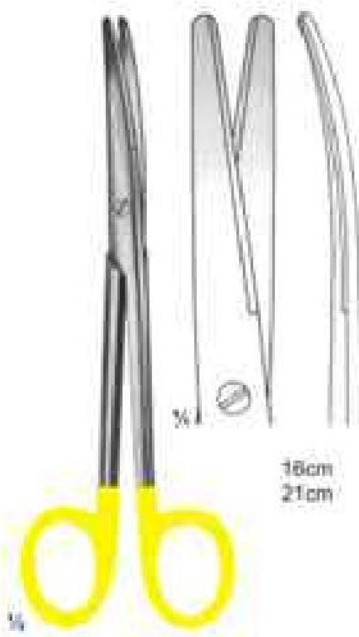

3012
LEXER
Curved
16, 21 cm

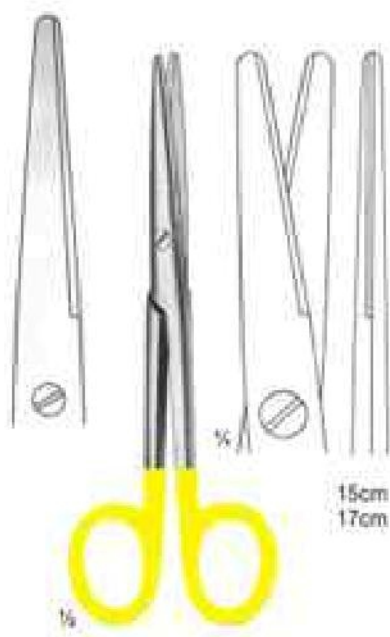

3014
MAYO-STILLE
Straight
15, 17 cm



3015
MAYO-STILLE
Curved
15, 17 cm



Scissors with Tungsten Carbide Inserts



**3016
METZENBAUM
Straight**

18cm 11.5cm
20cm 14.5cm
28cm 23.5cm
30cm 25.5cm



**3017
METZENBAUM
Curved**

11.5cm 14.5cm
23cm 25cm



**3018
METZENBAUM
Curved**

18cm 20cm
28cm 30cm



**3019
METZENBAUM FINO
Straight**

14cm 18cm 20cm
23cm 25cm 28cm



**3020
METZENBAUM FINO
Curved**

14cm 18cm 20cm
23cm 25cm 28cm



**3021
METZENBAUM FINO
Sharp**

14cm 18cm
20cm 23cm

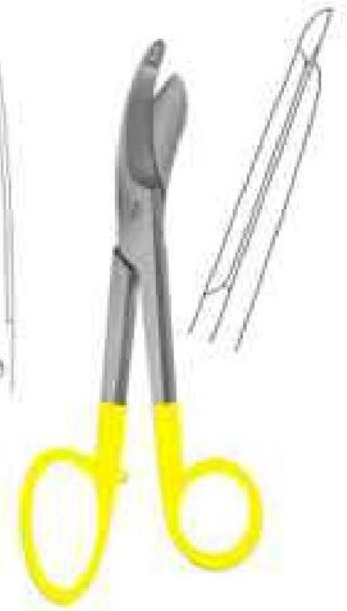

**3022
BRUNS
235 mm**



Scissors with Tungsten Carbide Inserts

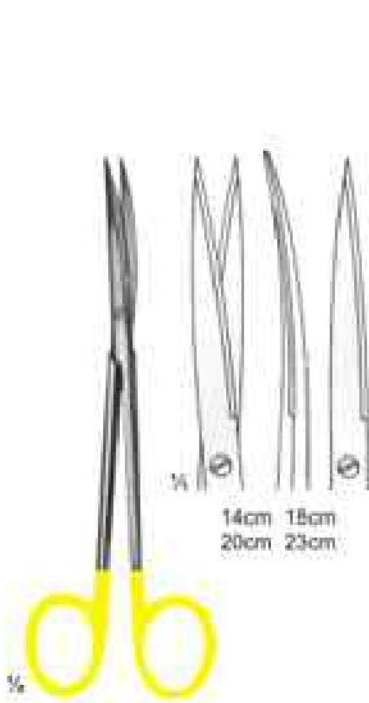

**3023
METZENBAUM FINO**

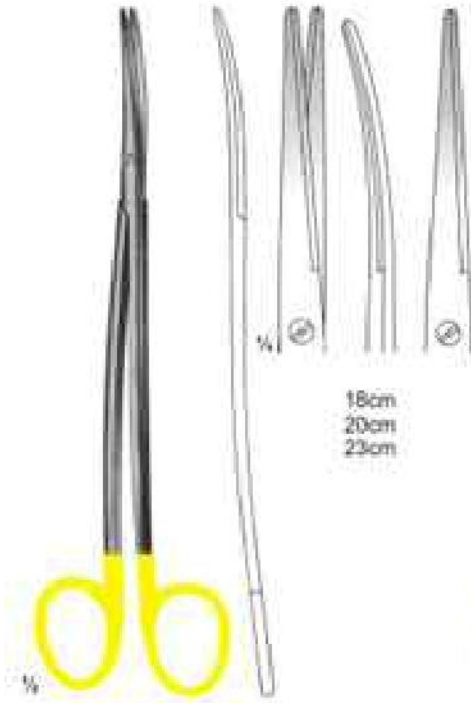

**3024
METZENBAUM FINO**

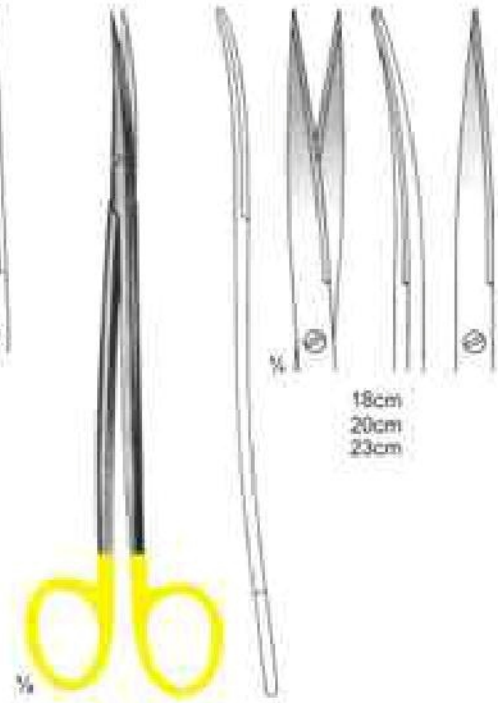

**3025
METZENBAUM FINO**



**3026
METZENBAUM FINO**

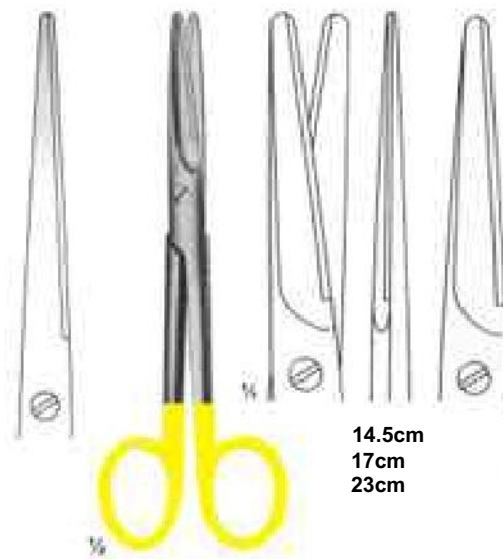

**3027
MAYO
Straight**

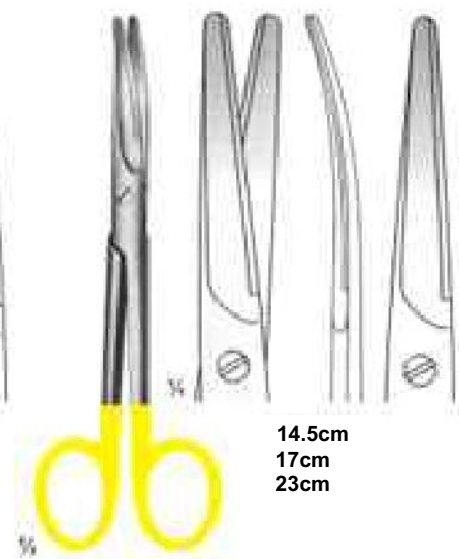

**3028
MAYO
Curved**



Scissors with Tungsten Carbide Inserts



3029
SIMS

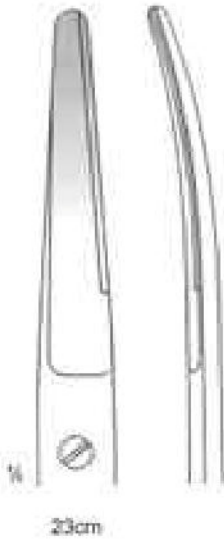

23cm

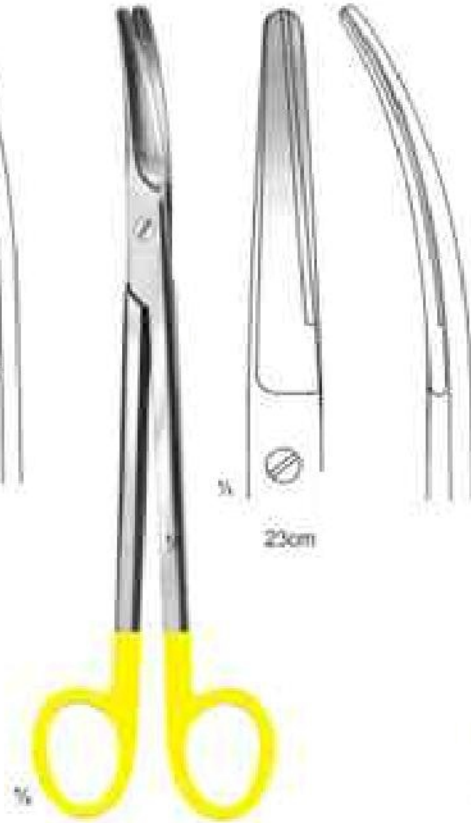

3030
PARAMETRIUM



23cm

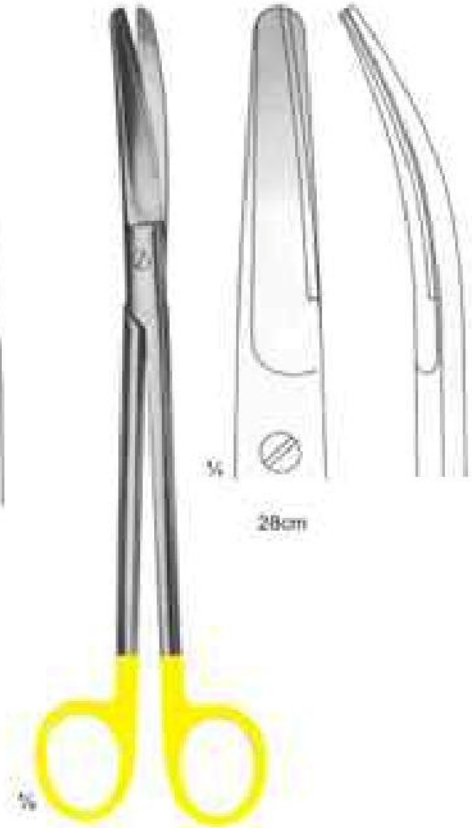

3031
MAYO-HARRINGTON

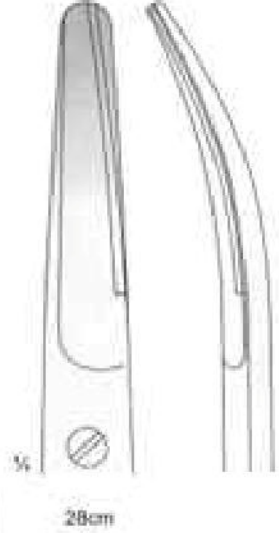

28cm



3032
KELLY
Straight 16cm



3033
KELLY
Curved 16cm



3033
DEAN
17cm



3035
LAGRANGE
Double-Curved
11.5cm



Scissors with Tungsten Carbide Inserts



3036
DE-BAKEY



3037
DE-BAKEY



3038
GOLDMAN FOX
13cm



3039
GOLDMAN FOX
Double Curved
13cm



3040
GOLDMAN FOX
13cm



3041
Fine Scissors
Straight
11, 5cm



3042
Fine Scissors
Curved
11, 5cm



3043
Fine Scissors
Angled
11, 5cm



3044
FAGNELL
Curved
12cm



**Scissors & Dissecting Forceps
With Tungsten Carbide Inserts**



**3045
UNIVERSAL
12cm**

**3046
Ligature Scissors
1 Black & 1 Goldplated Ring**

**3047
MERIAM
16cm**

**3048
ADSON**

**3049
ADSON**

**3050
CUSHING
17.5cm**

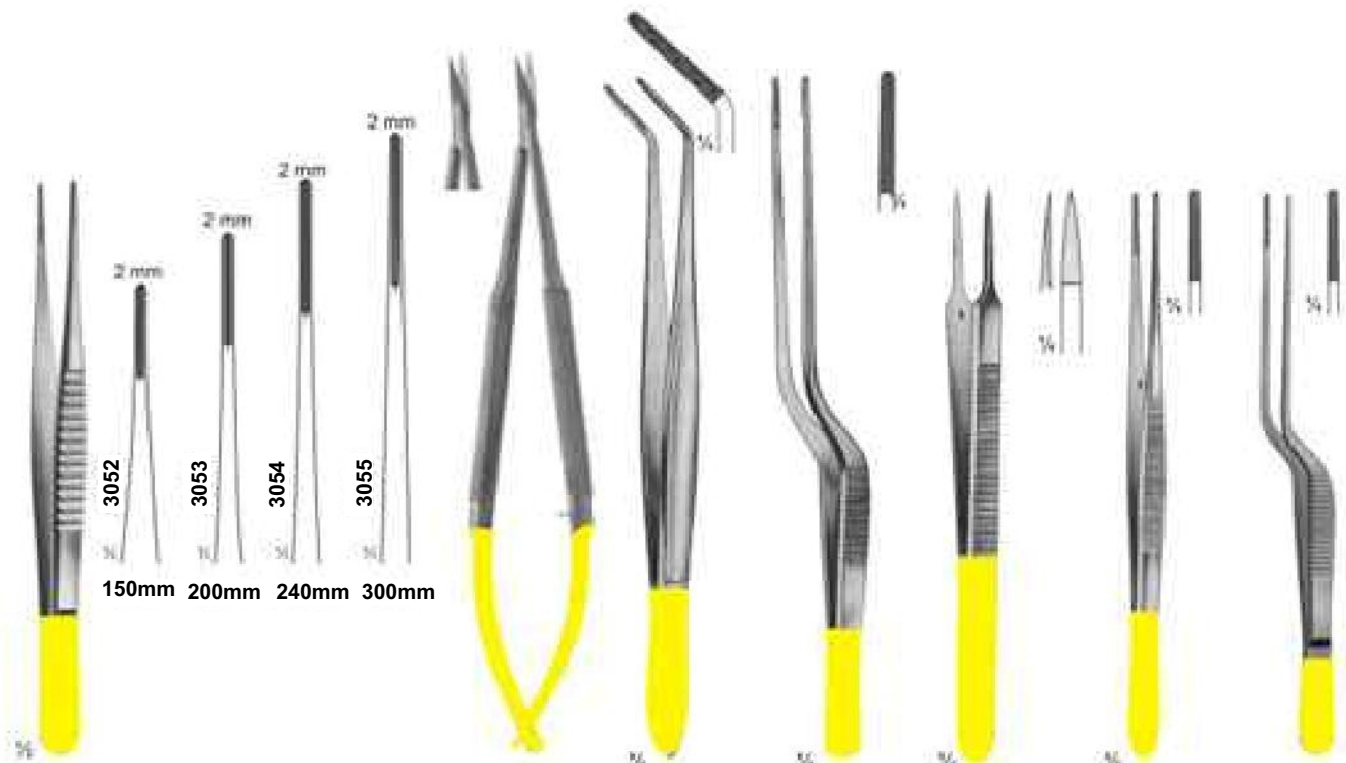

**3051
DEBAKEY
17.5cm**

**3056
CASTROVIEJO
Curved
15cm**

**3057
CUSHING
18cm**

**3058
CUSHING-
TAYLOR
18cm**

**3059
Dressing
Forceps
15cm**

**3060
SEMKEN
15cm**

3061



**Dissecting Forceps & Needle Holders
T.C Instruments**

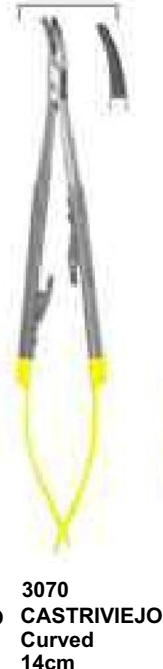
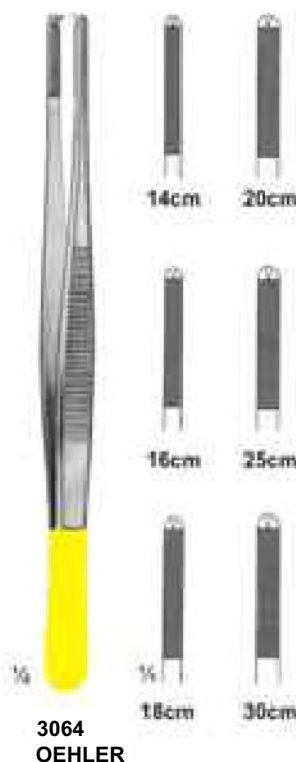
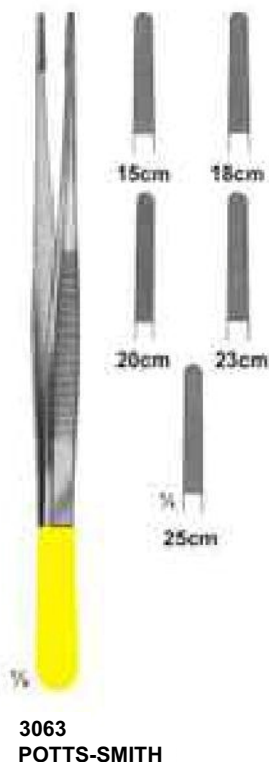



Needle Holders With T.C Inserts

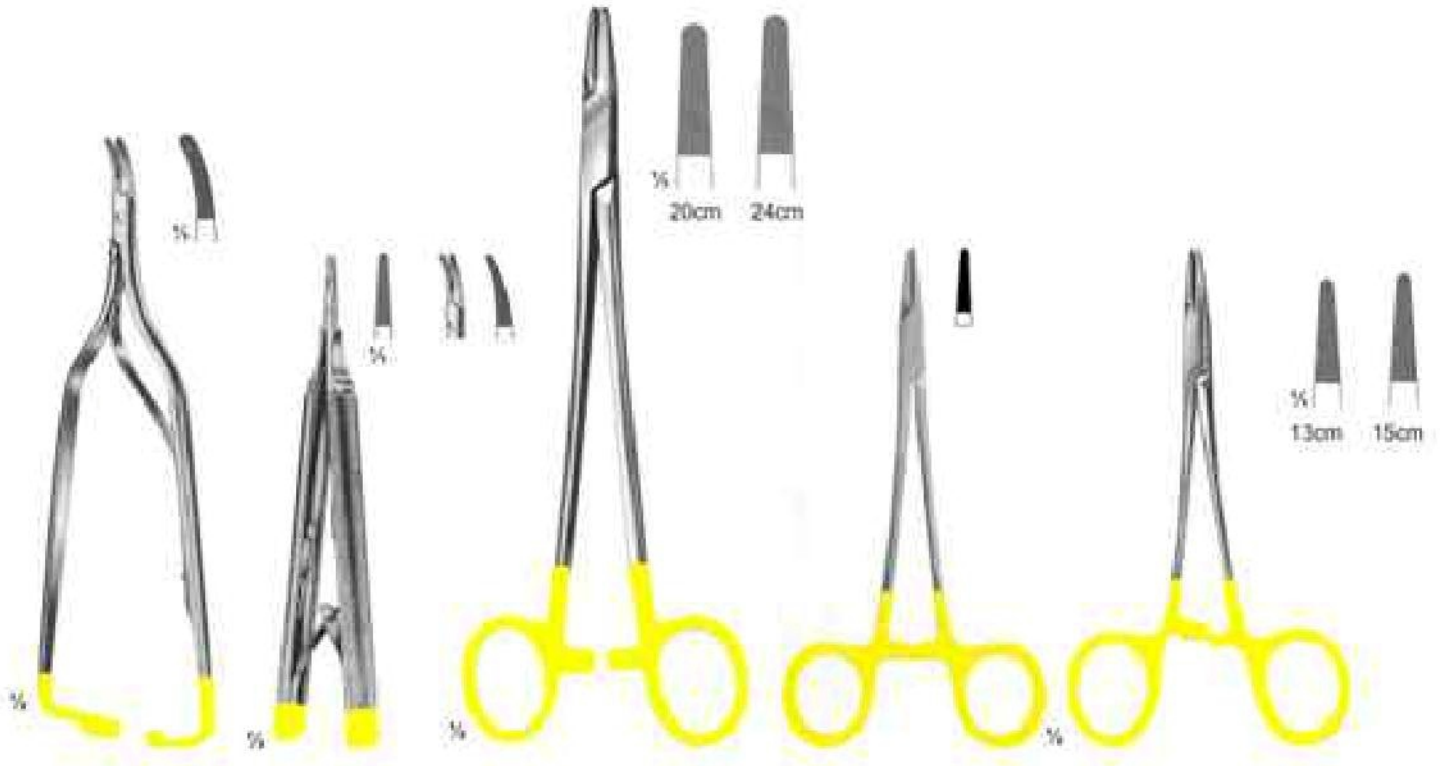

3075
ARRUGA
Curved
16cm

3076
CARTROVIEJO
13cm

3077
HEGAR
20, 24cm

3078
SMOOTH TIP
15cm

3079
HALSEY
13, 15cm

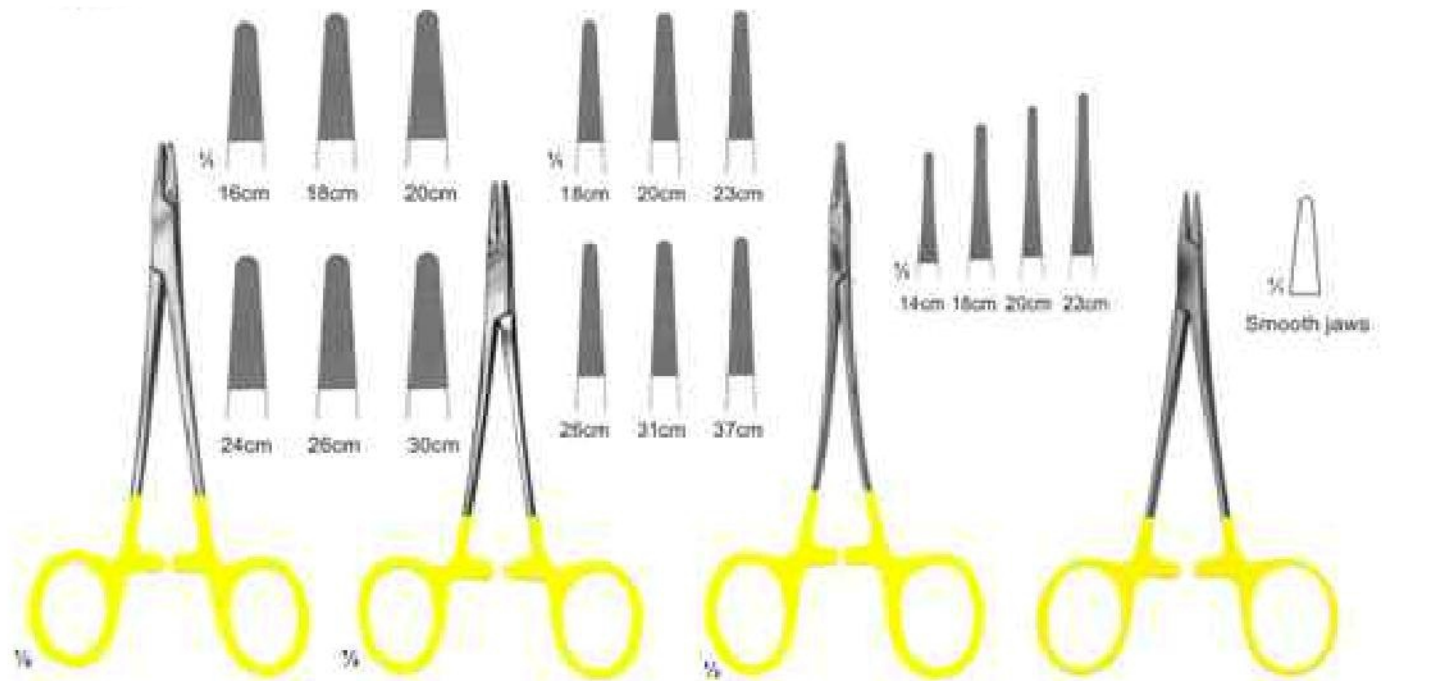

3080
MAYO-HEGAR

3081
DE BAKEY

3082
HEGAR VASCULAR

3083
WEBSTER
125mm



Needle Holders With Tungsten Carbide Inserts



3084
BOZEMANN WERTHEIM
20, 24, 26 cm

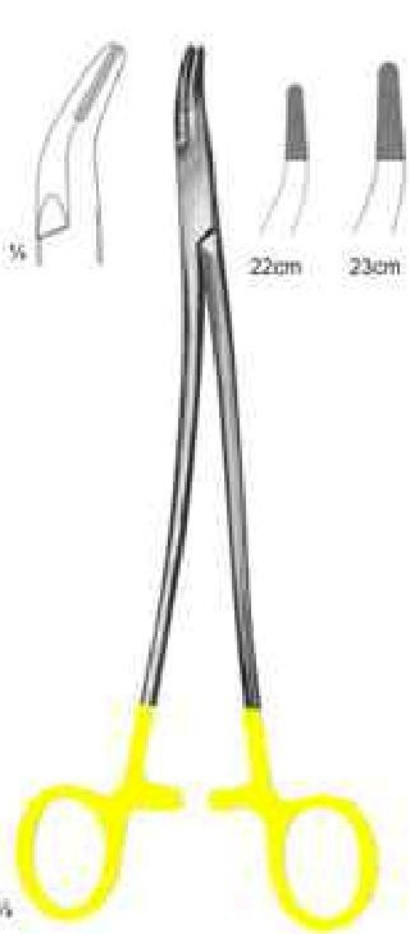

3085
BTRATTE

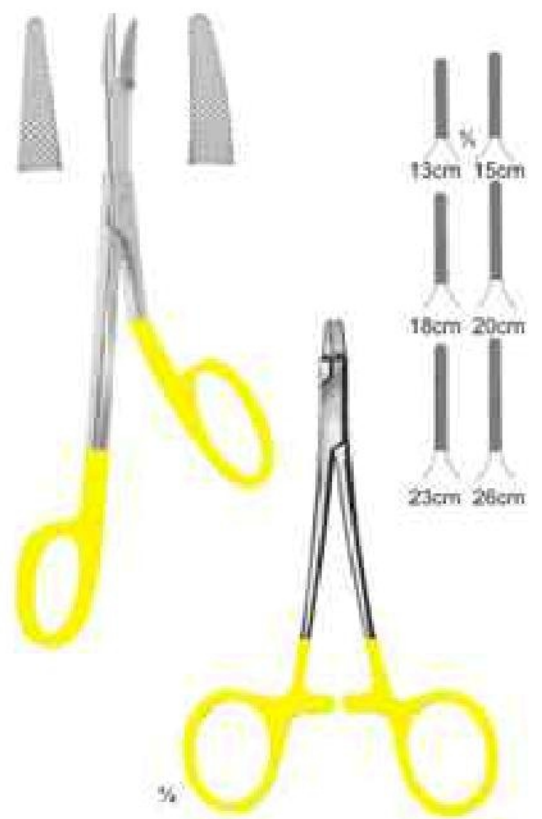

3086
RYDER



3087
RYDER-VASCULAR

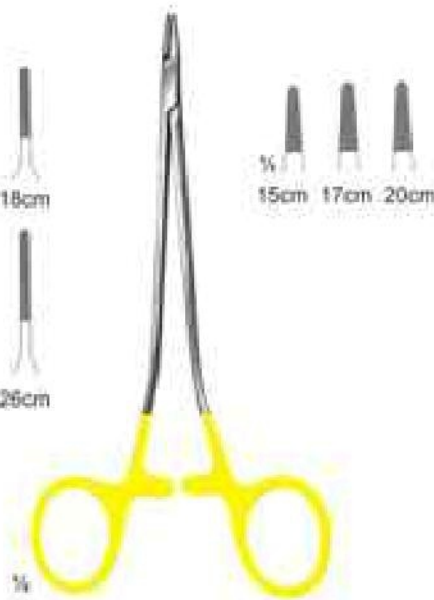

3088
MARTIN

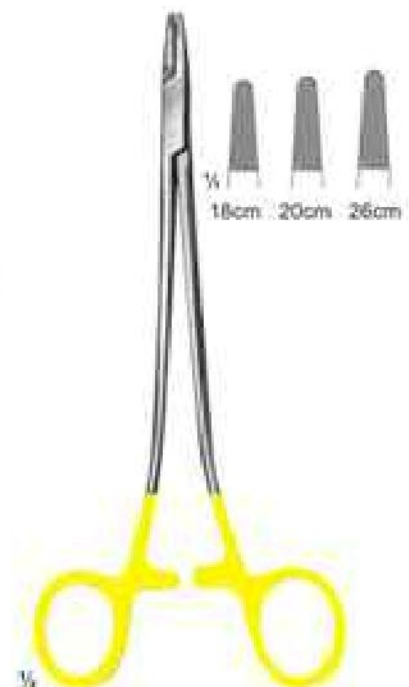

3089
SAROT



**Needle Holders With
Tungsten Carbide Inserts**

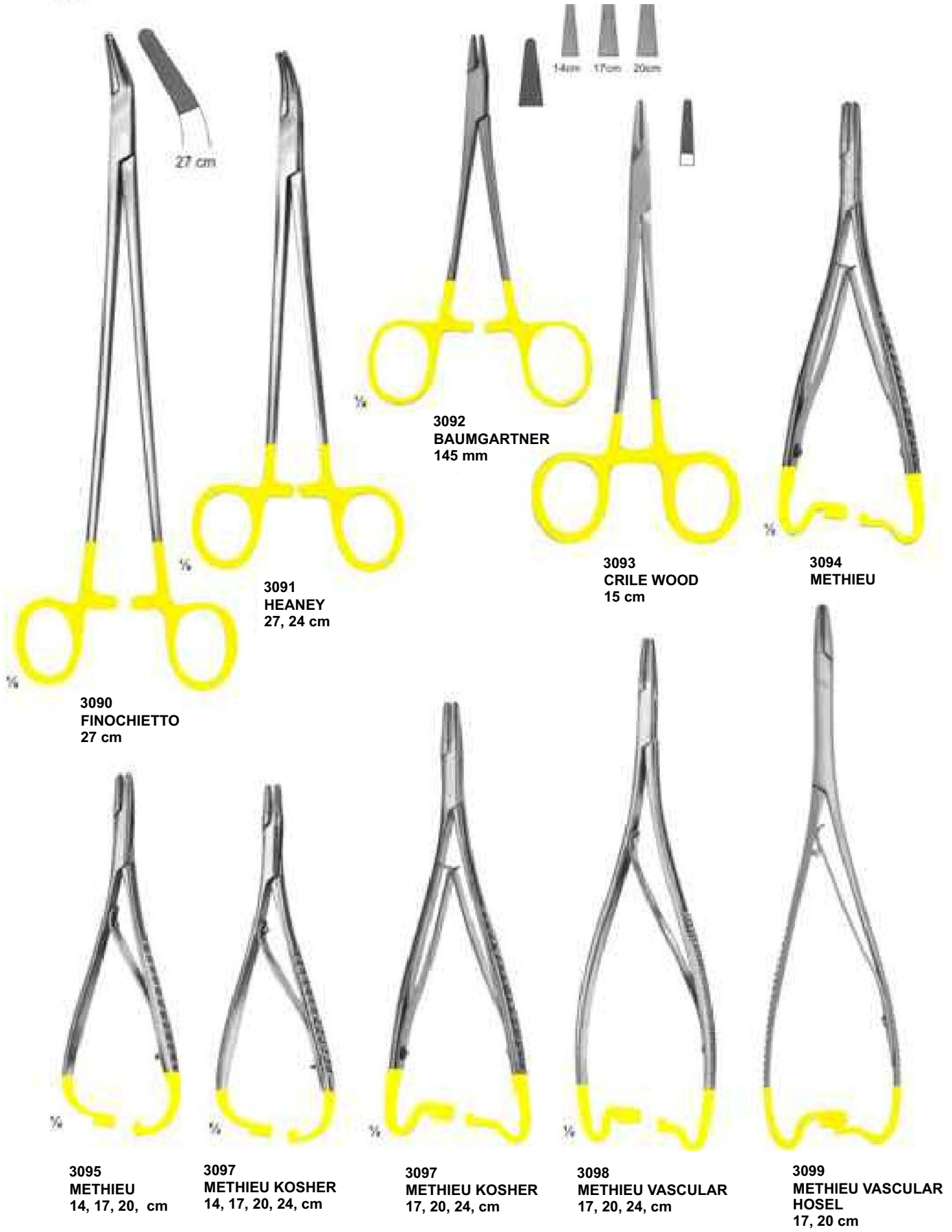

**3090
FINOCHIETTO**
27 cm

**3091
HEANEY**
27, 24 cm

**3092
BAUMGARTNER**
145 mm

**3093
CRILE WOOD**
15 cm

**3094
METHIEU**

**3095
METHIEU**
14, 17, 20, cm

**3097
METHIEU KOSHER**
14, 17, 20, 24, cm

**3097
METHIEU KOSHER**
17, 20, 24, cm

**3098
METHIEU VASCULAR**
17, 20, 24, cm

**3099
METHIEU VASCULAR
HOSEL**
17, 20 cm



Needle Holders With Tungsten Carbide Inserts



3100
METHIEU RYDER
17,20,24 cm

3101
Hosel
Curved
20 cm

3102
LANGENBECK
20 cm

3103
LANGENBECK
20,25 cm

3104
LANGENBECK
20,25 cm



3105
LUEHTY BECK
20, 25 cm

3106
LUEHTY BECK
20, 25 cm

3107
LANGENBECK
18,20,23 cm

3108
LANGENBECK
18,20,23 cm



Wire Cutter Pliers With Tungsten Carbide Inserts



3109 TOENNIS
Elastic pattern for dura or intestinal suture
180 mm



3110 Cutting Plier
12 cm

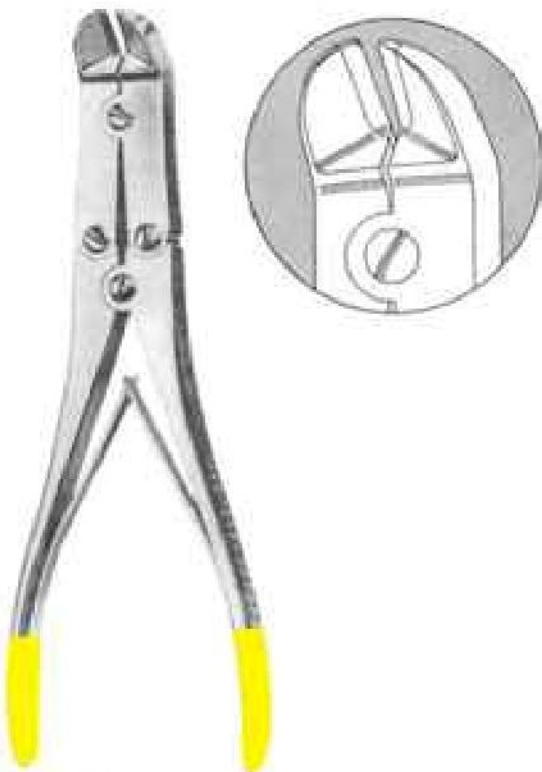

3111 MULLAR CLAUS
22 cm



3112 PLIER
17.5 cm



Alphabetical Index

A

Adams, Pliers	174
Aderer, Pliers	174
Adson, Forceps	158,207
Adson, Tweezers	151
Ainsworth, Rubber Dam Punch	147
Albee	143
Albrecht, Tweezers	155
Allen, Tweezers	155
Allis, Tissue Forceps	158
Amalgam Applicators	97
Amalgam Condensers	97
Amalgam Pluggers	97
Amalgam Carriers	145
Amalgam Guns	145
Andresen, Pliers	175
Andrews, Tongue Depressor	160
Angle, Pliers	169,174
Apical, Elevator	57,63
Arruga, T.C. Needle Holder	208,209
Articulators	194-195
Aspirating Syringes	149
Allen 9A, Elevator	50

B

Baby-Allis, Tissue Forceps	158
Band Removing Pliers	170
Bane, Rongeurs	179
Barnhart, Curettes	110,116
Barry, Elevator	66,69
Baum Gartner, Needle Holder	180,211
Bee Be, Scissors	186
Bein, Elevator	54,61
Beyer, Rongeurs	179
Bird Beak Pliers	167
Blumenthan, Rongeurs	176
Boley Gauge	143
Bone Curettes	129
Boynton, Needle Holder	181
Bozemann-Wertheim, T.C. Needle Holder	210
Bracket, Pliers	170
Brewer, Rubber Dam Instruments	147
Brown, Tissue Forceps	158
Brown-Adson, Tissue Forceps	158
Bruns, T.C. Scissors	203
Buchs, Retractor	162
Burnishers	99-100
Ball Chain	146
Boley Gauge,	143

Bone Gauge,	144
Bone Mill Forcep,	139
Bone Pluggers,	140
Bracket, Gauge	144
Buser, Elevator	52

C

Carvers	102,103
Castroviejo, Needle Holder	181,208,209
Castroviejo, scissors	186
Castroviejo, Gauge	144
Castroviejo, Sclerer Marker	144
Cement Instruments	118,119,121
Cement Spatulas	120,122
Chisels	103
Chompret, Elevator	63
Cleveland, Rongeurs	177,178
College, Tweezers	152,154
Collier, Needle Holder	180
Collin, Retractor	162
Columbia, Curettes	110,111,116
Composite Placement	104,105
Con Scodellino, Wax Knives	126
Cord Packers	95
Cottle, Scissors	184
Coupland, Elevator	58
Crane-Kaplan	128
Crile, Forceps	157
Crile, Needle Holder	181
Crile-Wood, Needle Holder	180
Crown Instruments	135,136
Crown Removers	134,135
Crown Shell, Pliers	166
Cryer, Elevator	55,58,69
Cushing, T.C. Forceps	207
Cushing, Tweezers	151
Cushing-Taylor, T.C. Forceps	207

D

De Bakey, T.C. Forceps	207
De Bakey, Scissors	184,186,206
De Bakey, T.C. Needle Holder	209
De La Rosa, Pliers	169
Deaver, Scissors	184
Denhart, Mouth Gag	160
Derf, Needle Holder	180
Disposable Products	117
Dr.Sader, Elevator	69
Dressing Forceps	207
Dean Scissors	186,205



Alphabetical Index



E

Elevators	51
Endodontic Condensers	86,87
Emert, Wax Knives	126
Excavators	89-91
Explorers	80-82,91-94
Extracting forceps (American Pattern)	36-49
Extracting forceps (English Pattern)	1-24
Extracting forceps (fitting handle)	25-33
Extracting forceps (For Children)	34

F

Fahnenstock, Wax Knives	126
Files	125
Filling Instruments	106,107
Fine, T.C. Scissors	206
Finocchio, T.C. Needle Holder	211
Finocchio, T.C. Needle Holder	211
Fischer, Pliers	175
Flagg, Tweezers	154
Flohr, Elevator	56
Fomon, Tissue Retractor	164
Freer, Elevator	52
Friedman, Rongeurs	178
Furrer, Pliers	174
Film Hanger	146
Finger Cup	197
Flohr, Elevator	57
Freer	15,16
Elevator	52

G

Gardner, Bone Chisels	132
Gardner, Needle Holder	180
Gardner, Rongeurs	178
Gillies, Hook	164
Gillies, Tweezers	151
Goldman Fox, T.C. Scissors	206
Goldman Fox, Curettes	112,113
Goldman Fox 14, Elevator	50
Goldman Fox, knives	114
Goslee, Pliers	175
Gracey Curettes	108,109,116

H

Halsey, T.C. Needle Holder	209
Handles	72
Hartman, Rongeurs	179

Hatchets	95
Heaney, T.C. Needle Holder	211
Hegar, T.C. Needle Holder	209
Hegar-Vascular, T.C. Needle Holder	209
Heidbrink, Elevator	64,67,69
Heidbrink, Elevator	57
Howard 9H, Elevator	52
Height Gauge,	143
Hepp-Scheidle, T.C. Needle Holder	208
Hlasted-Mosquito, Forceps	159
Hoes	95,125
Hollow Wares	196-200
How, Pliers	167,174
Howard, Bone Files	131
Hylin, Elevator	61

I

Implants Instruments	
Impression Trays	137-141
Iris Scissors	187-193
Ivory, Rubber Dam Instruments	183
	147

J

Jarabak, Pliers	165
Joseph, Scissors	183
Johnson, Pliers	169,175
Joseph, Tissue Retractor	164

K

Kait, T.C. Needle Holder	208
Kelly, Forceps	159
Kelly, Scissors	183
Kelly Scissors	205
Kim's Plier	165
Kirkland, knife	114
Knives	125
Knowles, Scissors	184
Kocher, Retractor	162
Kocher-Langenbeck, Retractor	162
Kopp, Elevator	60,68
Kopp, Tweezers	151

L

Lab & Office Pliers	166
Landgraf, Tweezers	154
Langenbeck, Pliers	175
Langenbeck, Retractor	162



Alphabetical Index



Langenbeck, T.C. Needle Holder	212
Langer, Curettes	110,116
Langhals, T.C. Needle Holder	212
Lecluse, Elevator	65
Lessmann, Wax Knives	126
Lexer, T.C. Scissors	202
Lichtenberg, T.C. Needle Holder	212
Ligature , T.C. Scissors	207
Lip & Cheek Retractors	161,162
Lister, Scissors	184
Littauer, Scissors	186
Littler, Scissors	184
Locklin, Scissors	186
London Hospital, Elevator	62
London-College, Tweezers	154,155
Lucae, T.C. Forceps	
Luehty-Beck, T.C. Needle Holder	212
Lwanson, Crown Gauge	143
Lagrange, Scissors	186,205
Littaure, Scissors	186
Lwanson, Crown Gauge	143

M

Martin, T.C. Needle Holder	210
Mathieu, Needle Holder	181,211
Mathieu-Kosher, T.C. Needle Holder	211
Mathieu-Ryder, T.C. Needle Holder	212
Mathieu-Vascular, T.C. Needle Holder	211
Mayo Harrington, T.C. Scissors	205
Mayo, Scissors	185,204
Mayo-Hegar, Needle Holder	181
Mayo-Hegar, T.C. Needle Holder	209
Mayo-Lexer, T.C. Scissors	202
Mayo-Stille, T.C. Scissors	202
Mayo-Stille Scissors	185
Mc Kellops, Pliers	175
Mecalls, Curettes	110,111,116
Mcindoe, Tweezers	151
Mead, Bone Mallets	133
Mead, Elevator	64
Mead, Rongeurs	179
Meriam , T.C. Forceps	207
Meriam, Tweezers	153,155
Metzenbaum Fino, T.C. Scissors	203,204
Metzenbaum, Scissors	185,203
Micro Surgery Set	182
Micro-Adson, Tweezers	151
Micro-Friedman, Rongeurs	178
Middeldorpf Retractor	162
Miller, Articulating Forceps	147
Miller, Bone Files	130

Mini-Blumenthan, Rongeurs	176
Molt, Elevator	50
Molt, Mouth Gag	160
Molt 9, Elevator	50
Morrison, Elevator	56
Mouth Mirrors with Handles	73
MSY, Pliers	175
Mullar Claus, Wire Cutting Pliers T.C.	213

N

Nance, Pliers	168,169,174
Napkin Holders	146
Neivert, Needle Holder	180
Nelson-Metzenbaum, Scissors	185
Non Chill	146

O

O'Brien, Pliers	168
Obturation Instruments	88
Ochsenbein	128
Ordan, knife	114
Oehler, T.C. Forceps	208
Olsen-Hegar, Needle Holder	180
Optical Pliers	168
Orthodontic Cutters, T.C.	172
Orthodontic Distal & Cutters	173
Orthodontic Pliers, T.C.	171
Ott, Elevator	62

P

Parametrium, T.C. Scissors	205
Partsch, Bone Chisels	133
Partsch, Bone Mallet	133
Pean, Forceps	157
Peeso, Pliers	166,175
Peets, Forceps	157
Perry, Tweezers	151
P.K. Thomas,	96
Pich,	98
Pluggers,	98
Prichard, Elevator	50
Plastic Handle Elevators	70
Polokoff, Bone File	131
Pott, Elevator	51
Potts-Smith, T.C. Forceps	208
Potts-Smith, T.C. Needle Holder	208
Probes	82-85,91,94

Q

Quinby, Scissors	183
------------------	-----



Alphabetical Index



R

Ragnell , T.C. Scissors	206
Retainers, Bands	146
Reynolds, Pliers	169,174
Root Planning Curettes	115
Root splinter forceps	35
Roux, Retractor	162
Rubber Dam Clamps	148
Rubber Dam Holder	147
Rule, Curette	110
Russian, Tissue Forceps	158
Ryder, T.C. Needle Holder	210
Ryder-Vascular, T.C. Needle Holder	210

S

Sarot, T.C. Needle Holder	210
Scalers	75-79
Scalpel Handles	71
Schwarz, Pliers	168,175
Schluger, File	114
Seldin, Elevator	50,55,67
Select, Tweezers	151
Semken, T.C. Forceps	207
Semkin, Tissue Forceps	158
Senn, Tissue Retractor	164
Separating Pliers	166
Sims, T.C. Scissors	205
Spatulas	123
Spencer, Scissors	186
Spencer-Wells, Forceps	157
Spreaders	87
Split Chisels,	128
Spring Bow Divider	143
Standard, T.C. Scissors	201
Standard, Tweezers	151
Steiner, Pliers	166
Sterilizing & Lab Instruments	156
Sterilizing Forceps,	163
Stevens, Needle Holder	181
Stevens, Scissors	183
Stille, Scissors	185
Stratte, T.C. Needle Holder	210
Strip Holder Clips	146
Syringes	150
Suction Tubes,	140,142
Sugarman, File	114

T

Toennis, Wire Cutting Pliers T.C.	213
-----------------------------------	-----

Toennis-Adson, Scissors	184
Toennis, Tissue Retractor	164
Towel Clamps, Napkin Holders	159
Tweed, Pliers	168
Telescope, Crown Plier	136
Traymann, Crown Remover	128

U

Universal , T.C. Scissors	207
Universal, Pliers	174
Universal, Elevator	135
Utility Plier	165

V

Vernier, Measuring Instruments	143
Vernier Gauge	143

W

Wakefield, Bone Chisels	132
Waldron, Pliers	174
Waldsachs, Pliers	174
Wangensteen, T.C. Forceps	208
Warwick-James, Elevator	62
Waugh, Tweezers	151
Wax & Modeling Carvers	120
Wax & Plaster Knives	127
Wax Carvers	101
Wax, Porcelain Instruments	118,119,121
Webster, Needle Holder	160,209
Weingart , Utility Pliers	167
Weitlaner, Retractor	160
West, Elevator	50
White, Rubber Dam Instrument	147
Wieder, Tongue Depressor	160
Winter, Elevator	65,69
Wire & Clasp Bending Pliers	170
Wire Bending Pliers	166
West, Elevator	50
Wire Cutter	165
Woodson,	98

Y

Young, Pliers	168,174
---------------	---------

Z

Zuricher, Measuring Instrument	143
Zuricher, Gauge	143



***Post: Islam Nagar Road, Pacca Garah,
Sialkot – 51310 - Pakistan***

Phone: +92–52-4261495

Fax: +92–52-4264970

Cell: +92-321-9408040

E-mail: sales@zartaas.com

URL: www.zartaas.com